

# CENTOR Star Touch R Advanced Touch Screen Force Gauge with External Sensor

TECHNOLOGIES  
**ANDILOG**



Centor Star Touch R

## The Power of material testing equipment up to 50kN

Functionality, accuracy, and precision formerly reserved for expensive and complex material testing equipment are now available with the Force Gauges **Centor Star Touch**. High accuracy of 0.1%, sample measurement rates up to 5000 Hz, internal memory, measuring peaks and graphical display are just the beginning features. The **Centor Star Touch** can provide break force, average, curve force versus time or deflection, statistical calculations and real time pass/fail analysis based on user supplied tolerances. Data logging and communication to your computer or network is available with RS232 or USB ports.

**Centor Star Touch** is designed for manufacturing environments, providing performance and easy operations to use and understand

with the addition of the new, colored touch screen technology. icons guide the operator in the selection of the appropriate measurement technique and method for their application.

Setup menus, prompts and results are available in multiple languages. When integrated in manufacturing processes, the Centor Touch can communicate with programmable logic controllers through fast TTL outputs.

**With the combined features of functionality, flexibility and simplicity, the Centor Star Touch is the solution for more sophisticated and economically feasible testing solutions for the factory floor.**

## Specifications

FEATURES	CENTOR STAR TOUCH R
Accuracy	0,1 % FS
Resolution	1/10 000 FS
Sampling rate	5 000 Hz
Overload protection	200% FS
Units	KN,N, Lb, Kg, g, Oz
Auto-off	Adjustable from 5 to 15 minutes
Bargraph	✓
Peak in tension and compression	✓
Display peak and current reading in the same time	✓
Display of the Force/Time graph	✓
Can be used with a pedal	✓
Tare	✓
Programmable set points	✓
Average and standard deviation	✓
Memory	1000 Results or 1 curve
Reversible display	90° et 180°
Operates on rechargeable batteries	✓
8h Operation without recharging	✓
Fast charge	✓
Low battery indicator	✓
Metal casing & Protective elastomer	✓
Threaded fixing holes on the back	✓
RS232 output or USB	Send current reading, peak, minimum, calculation
Continuous transmissions	1000 values per second+/- 1V

### Innovations :

- Automatic recognition of external force and torque sensors
- Horizontal or vertical display
- Color touch screen
- USB output
- User friendly interface
- Memory card reader compatible

### Integrated calculations:

- Maxima in a time window
- Time to reach maximum effort
- Average force between a period of time
- Force at time T
- Break point
- Derivative
- First peak
- Force on opening / closing of contact
- Average force

## Accessories

Supplied in a carrying case with power supply and a certificate of calibration.



## Models and Capacities

MODELS	CAPACITY	ACCURACY	RESOLUTIONS
CNR CT R 20	20	0.02 N	0.002 N
CNR CT R 50	50	0.05 N	0.005 N
CNR CT R 100	100	0.1 N	0.01 N
CNR CT R 200	200	0.2 N	0.02 N
CNR CT R 500	500	0.5 N	0.05 N
CNR CT R 1000	1000	1 N	0.1 N
CNR CT R 2000	2000	2N	0.2 N
CNR CT R 5000	5000	5 N	0.5 N
CNR CT R 10000	10 000	10 N	1 N
CNR CT R 20000	20 000	20 N	2 N
CNR CT R 50000	50 000	50 N	5 N

# CENTOR Star Touch R Advanced Touch Screen Force Gauge with External Sensor

TECHNOLOGIES 



## Measure screen



Battery indicator

Force gauge maximum capacity 500 N

Statistics

Graph displayed gauge vs time

Main display programmable

Measurement direction

Sending data through RS232

Secondary display programmable

Analog load bar with set point marker

TTL output status

## Usability



EASY : Menu

Affichage

ESSAI

Statistiques

Communication

Général

Maintenance

The Centor star touch has simple and user-friendly menus, thanks to its large color screen. The setting of the force gauge and the test configurations are done using the touch screen: keyboard, down menu, icons...



Temps d'attente avant baisse de luminosité

30 sec

7 8 9

4 5 6

1 2 3

0

## Options - Software



Caligraph compatible : Data acquisition and analysis of curves with realtime graphing through RS232 or USB.

DATASTICK allows you to save your data on a USB stick in one click, whether you are doing your measurement indoors or outdoors on the field, we propose you a complete mobile solution.



## Options

Enjoy all the features of your force gauge CENTOR STAR TOUCH and upgrade it to its Table top version



# CENTOR Star Touch R Advanced Touch Screen Force Gauge with External Sensor

TECHNOLOGIES  
**ANDILOG**

## Inputs/Outputs

Connector for USB, RS232, analogic, Memory Card reader Datastick, 6 TTL outputs and 3 TTL inputs

Connector SPiP: plug additional remote force or torque sensor. Sensors are automatically recognized on your [Centor Star Touch](#) gauge

The [Centor Star Touch](#) is a highly flexible unit thanks to its many inputs and outputs for communication with peripheral devices such as computers, programmable logic controllers, memory card reader...

Data can be send on continue or on demand to a computer. Also the [Centor Star Touch](#) can be automated with a logic controller or a computer in order to: start a test, tare the value, and send a stop bit when reach a set value...

The SPiP connector allows you to turn your force gauge into a torque gauge without any change.



## Reversible display

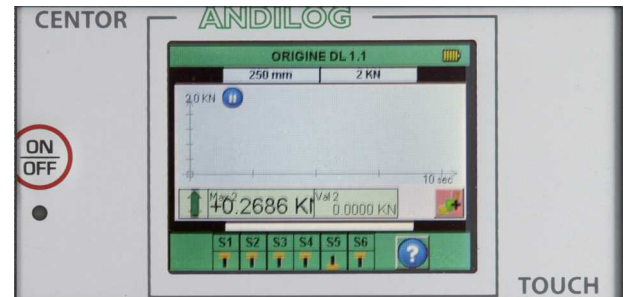

The Centor Star Touch screen is reversible without disassembly the gauge. it is possible to rotate by 90°, 180° or 270°.

This setup is done through the menu of the [Centor Star Touch](#).

This feature is useful for horizontal tests and for incorporation of the gauge on panel mount.

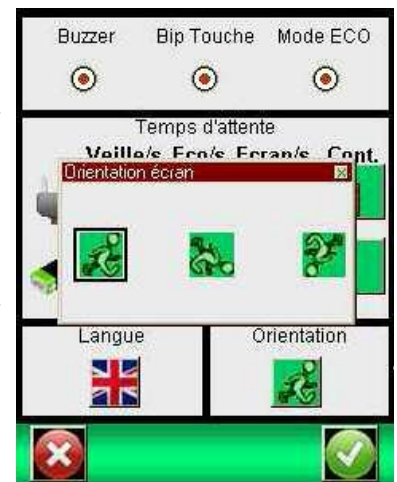

## Force Sets Points feature

The Centor Star Touch offers force limit feature. High and low thresholds values can be set.

Once limits have been setup, they automatically appear on graphic bargraph. The color of the current reading changes when the limits are exceed and the buzzer can be activated.

The TTL output can be activated on force limits values. This allow by example the send a stop command to a motorized test stand when it reaches the force threshold, and so ensure a security for the sensor against overload.

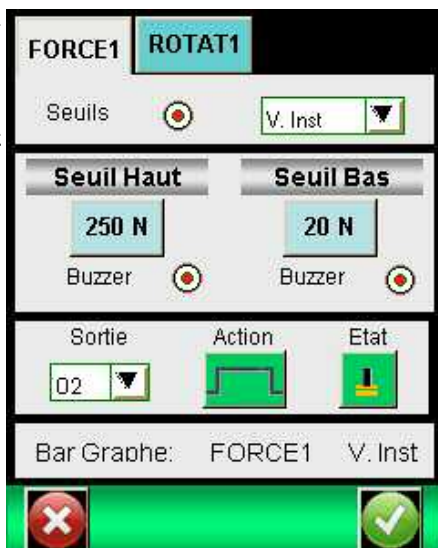

## Test

The [Centor Star Touch](#) can operate in two different measurement modes: continuous and test. Under continuous mode, the force gauge measure permanently the force but it can't plot the graph or determine specific calculations.

Under the test mode, the [Centor Star Touch](#) operates at its maximum capacities: setup a time per test, start you test on demand (through a pedal, computer or programmable logic controllers), plot the graph, specific calculations, TTL output activation...

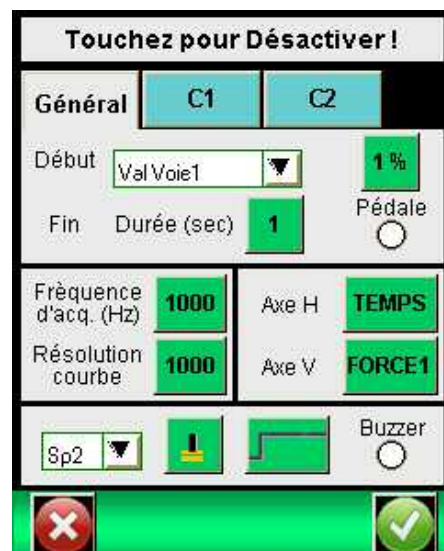

# CENTOR Star Touch R Advanced Touch Screen Force Gauge with External Sensor



## Sensor dimensions

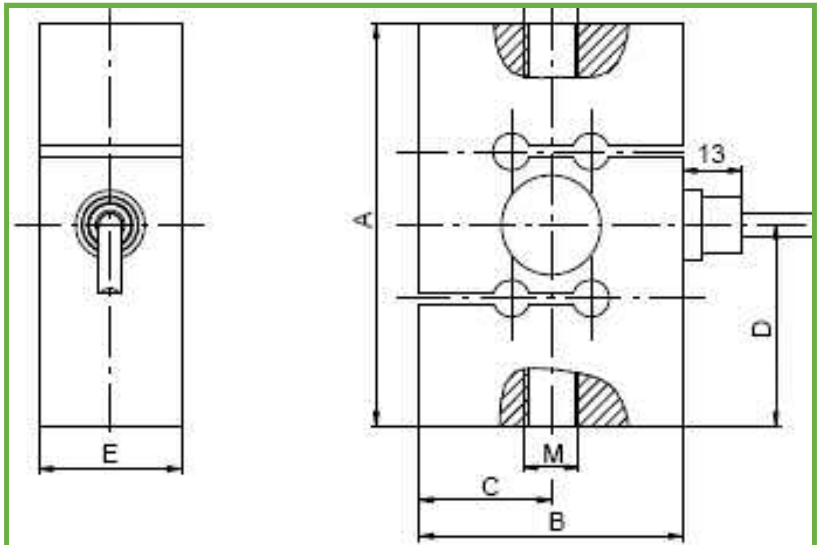
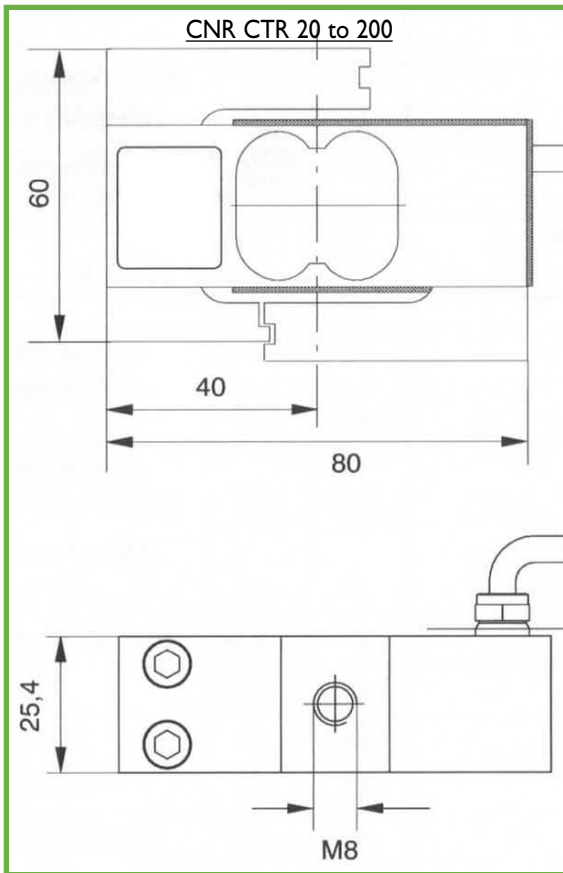

## Models and capacities

MODELS	A	B	C	D	E	M
CNR CTR 500	62	50.8	25.4	31	24	M8
CNR CTR 1000	62	50.8	25.4	31	24	M8
CNR CTR 2000	87.3	57.2	28.6	43.7	24	M12
CNR CTR 5000	87.3	57.2	28.6	43.7	31	M12
CNR CTR 10000	87.3	57.2	28.6	43.7	31	M12
CNR CTR 20000	100	69.8	34.9	50	31	M24x2
CNR CTR 50000	100	76.2	38.1	50	36.5	M24x2

## Option - Sensors

In option, we have a large variety of sensors in order to comply with your dimensions and applications. Feel free to contact us.



## Housing dimensions

