

# Operating manual

## ATLAS II

### V3.2

**ANDILOG Technologies** - BP62001 - 13845 Vitrolles Cedex 9 - France

Email : [info@andilog.com](mailto:info@andilog.com) Site : [www.andilog.com](http://www.andilog.com)

Tel: +33 820.888.202 – Fax: +33 820.888.902

**COM-TEN Industrie** - 6405 49<sup>TH</sup> Street - FL, 33781 Pinellas Park – USA

Email: [sales@com-ten.com](mailto:sales@com-ten.com) Web: [www.com-ten.com](http://www.com-ten.com)

Ph:+1 727 520 1200 – Fax:+1 727 520 0299

## Table of contents

1.	Introduction .....	3
1.	Presentation .....	3
2.	Definitions .....	3
2.	Setup .....	4
1.	Opening .....	4
2.	Recommendations before use .....	4
3.	Starting your System .....	6
3.	Displacement of the ATLAS II .....	13
1.	Remote control.....	13
2.	Travel Settings .....	14
3.	Start a Test.....	17
4.	High Speed Travel.....	18
5.	Reset the position.....	18
6.	Units .....	18
7.	Change the language .....	18
8.	TTL Input of the Drivepack .....	19
9.	The TTL Output of the Drivepack .....	19
4.	Measuring with the ATLAS .....	20
1.	Main measuring display .....	20
2.	The different tactile area of the display .....	21
3.	Main menu .....	22
4.	Zero or Tare .....	22
5.	Backlight .....	22
5.	Your first measurements.....	23
1.	Start measuring .....	23
2.	State indicator .....	23
3.	Curve area .....	24
6.	Setup the display.....	25
7.	Setup limits.....	26
1.	Activate / Deactivate .....	26
2.	Sensor tab.....	26
3.	Choose the type of value.....	26
4.	Setup the limits.....	26
5.	Stop the test stand with a limit .....	27
8.	Setup test and graph.....	28
1.	Test tab.....	28
2.	Setup a test.....	28
9.	Calculations.....	30
1.	Choose the calculations.....	30
2.	Action following a calculation .....	31
10.	Statistics and memory .....	31
1.	Setup.....	31
2.	How to save the data.....	32
11.	Communication .....	33
1.	RS232.....	34
2.	USB .....	35
3.	Bluetooth.....	35
4.	Analog.....	35
5.	DATASTICK – USB Memory Stick (optional).....	35

12.	TTL input / output and foot pedal.....	38
1.	Outputs of the Centor Touch Dual .....	38
2.	Inputs and pedal.....	39
13.	General settings.....	40
1.	Buzzer .....	40
2.	ECO mode.....	40
3.	Times out settings .....	40
4.	Screen orientation.....	40
5.	Language .....	40
14.	Maintenance.....	41
1.	General .....	41
2.	Date and time .....	41
3.	Channels .....	41
4.	Factory setting.....	41
15.	Examples of test setup .....	42
1.	Overload Protection .....	42
2.	TOPLOAD test – crushing bottle .....	43
2.1.	Set the Centor Touch.....	43
2.2.	Set the Drivepack command .....	44
2.3.	Test protocol .....	44
3.	Compression spring test.....	44
3.1.	Drivepack configuration .....	45
3.2.	Centor Touch configuration .....	46
3.3.	Set the original position of the ATLAS.....	46
3.4.	Start the test.....	46
4.	Peeling test.....	47
4.1.	Drivepack setup.....	47
4.2.	Centor Touch configuration .....	47
4.3.	Start test.....	48
5.	Wire cable.....	48
5.1.	Drivepack configuration .....	48
5.2.	Centor touch configuration .....	48
5.3.	Start the test.....	48
16.	Annexes .....	49
1.	Software .....	49
2.	Cables .....	49
3.	Security housing .....	49
4.	Error message.....	49
5.	Factory settings .....	52
6.	Connections.....	53

Revision	Date	Description
3.0	18/12/2014	Creation
3.1	28/08/2015	§3
3.2	22/10/2015	§2.3.2

## 1. Introduction

### 1. Presentation

Thank you for choosing the motorized test stand ATLAS II to perform your tensile and compression force tests. This test system is the result of 20 years experience in force and torque testing measurement.

Using the advanced graphical display, the ATLAS II is easy to use and has a friendly user interface. This operating manual will guide you during your first tests. At the end of the operating manual, you will find advanced testing examples.

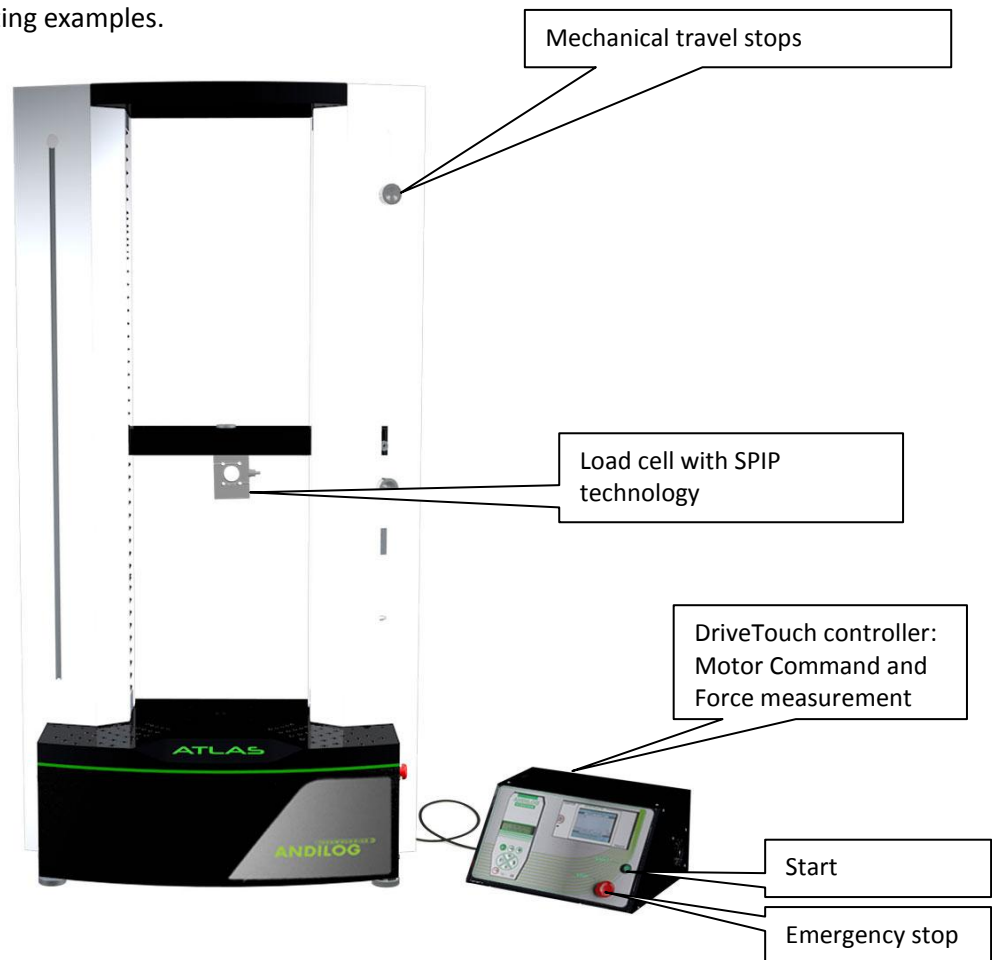

### 2. Definitions

To help you during the reading of this Operating Manual, please find below some definitions.

**SPIP:** The SPIP is a technology developed by Andilog Technologies allowing automatic recognition of external sensors by our force gauge, torque gauge and test stand. This system can store the sensor settings as the capacity, serial number and calibration parameters.

**CALIBRATION:** The force gauges and load cells are calibrated by ANDILOG Technologies and always delivered with a certificate of calibration according to COFRAC standard. It is generally recommended to re-calibrate your equipment once a year unless different internal procedure of your company applied. ANDILOG Technologies guarantee a full check up of your equipment, with software update and also the adjustment of the calibration to ensure perfect accuracy of your force gauge.

## 2. Setup

**NOTE:** Before using the ATLAS II, please check that the test stand has not been damaged during shipping. If you have any questions, please contact ANDILOG TECHNOLOGIES to check that you have all the information to perform your tests.

### 1. Opening

The motorized test stand ATLAS II includes: (standard setup without accessories and options)

- One load cell
- One certificate of calibration
- One power cable

### 2. Recommendations before use

#### 1. Load Cell

In spite of its mechanical protection, sensory overload can damage the instrument. The instrument stops if the capacity has been exceeded 10 times. You have to return it to ANDILOG TECHNOLOGIES for checking.

It is important that measured values are under 90% of the sensor capacity.

Used the sensor constantly above 90% of its capacity may cause premature wear of this one. Also when the sensor is used on a motorized test stand, it is necessary to setup a stop limit when the force is close to the maximum capacity. This limit must take into account the fact that at high speed, large frame doesn't stop immediately and the risk of damaging the sensor is high due to the inertia of the motor.

#### 2. During the tests

Most of the tests done with ANDILOG Technologies instruments are destructive test. Dangers associates with these type of tests require that the users are experienced and trained. Due to the nature and use of the equipment sold by ANDILOG Technologies, acceptance by the purchaser of technology products Andilog constitutes acceptance of risks and damages that may result from the use of devices Andilog.

#### 3. Conditions

- Working Temperature : 0 to 35° C
- Stock Temperature: -20 to 45° C
- Humidity: 5 % to 95 %,
- Altitude: 3 000 m

#### 4. Warranty

Subject to the provisions and conditions hereof, ANDILOG technologies warrants to the buyer that, without charge, ANDILOG TECHNOLOGIES will repair or replace, at its option, all new equipment sold

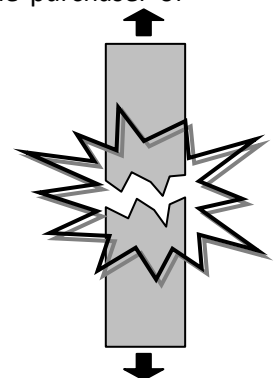

to Buyer when used and maintained in the course of normal operations and conditions, if Buyer finds defects in workmanship and materials during a period of one (1) year from the date of shipment.

- A. The conditions hereof are:
  - 1. ANDILOG Technologies has been notified in writing by the Buyer of the defect prior to the termination of the warranty period.
  - 2. The goods are shipped to ANDILOG Technologies with prior approval.

**CAUTION** **ALL WARRANTY WORK IS DONE AT THE FACTORY. YOU WILL NEED TO SAVE THE SHIPPING CONTAINER SHOULD YOUR TESTER NEED TO BE RETURNED TO THE FACTORY. THE USE OF AN IMPROPER SHIPPING CONTAINER USUALLY RESULTS IN DAMAGE TO THE TESTER AND ADDITIONAL CHARGES.**

- 3. All shipping costs have been paid by the Buyer.
  - 4. The goods have been used and maintained under normal operating conditions.
- B. Repair or replacement shall be the Buyer's sole and exclusive remedy in the event of ANDILOG Technologies' breach of this warranty.
- C. This express warranty is in lieu of all other warranties, expressed or implied, including the implied warranties of merchantability and fitness for a particular intended purpose, with the exception of the implied warranty of title.
- D. The purpose of the equipment manufactured by ANDILOG technologies is destructive testing, and the inherent danger associated with such testing requires the equipment to be used only by experienced operators. Due to the nature and use of the equipment, Buyer's acceptance of the ANDILOG Technologies equipment constitutes Buyer's assumption of all risk and liability arising out of or resulting from the use of ANDILOG technologies equipment.
- E. In no event will ANDILOG Technologies be liable for damages, lost revenue, lost wages, lost savings or any other incidental or consequential damage arising from the purchase, use or inability to use said product, even if ANDILOG Technologies has been advised of the possibility of such damages.

**ANDILOG TECHNOLOGIES WILL IN NO EVENT BE LIABLE FOR ANY INJURY OR INDIRECT, INCIDENTAL OR CONSEQUENTIAL DAMAGES RESULTING FROM THE USE OF ITS EQUIPMENT.**

Accuracy is guaranteed at time of shipment to be as advertised or quoted.

If products are damaged in shipment, notify shipping company and ANDILOG technologies immediately.

Warranty void for damage due to accident, misuse or abuse.

### 3. Starting your System

#### 1. Connecting the DriveTouch controller

- Place the DriveTouch on the work bench or table next to the Test Stand
- Connect the power cord to the DriveTouch and plug it into a surge protected power source.
- Connect the large umbilical cable between the DriveTouch and the Test Stand. **The cable is keyed. The large key notch should be up. Align connector end key and push cable into connector. Rotate connector lock COLLAR 90 degrees clockwise to lock connection.**

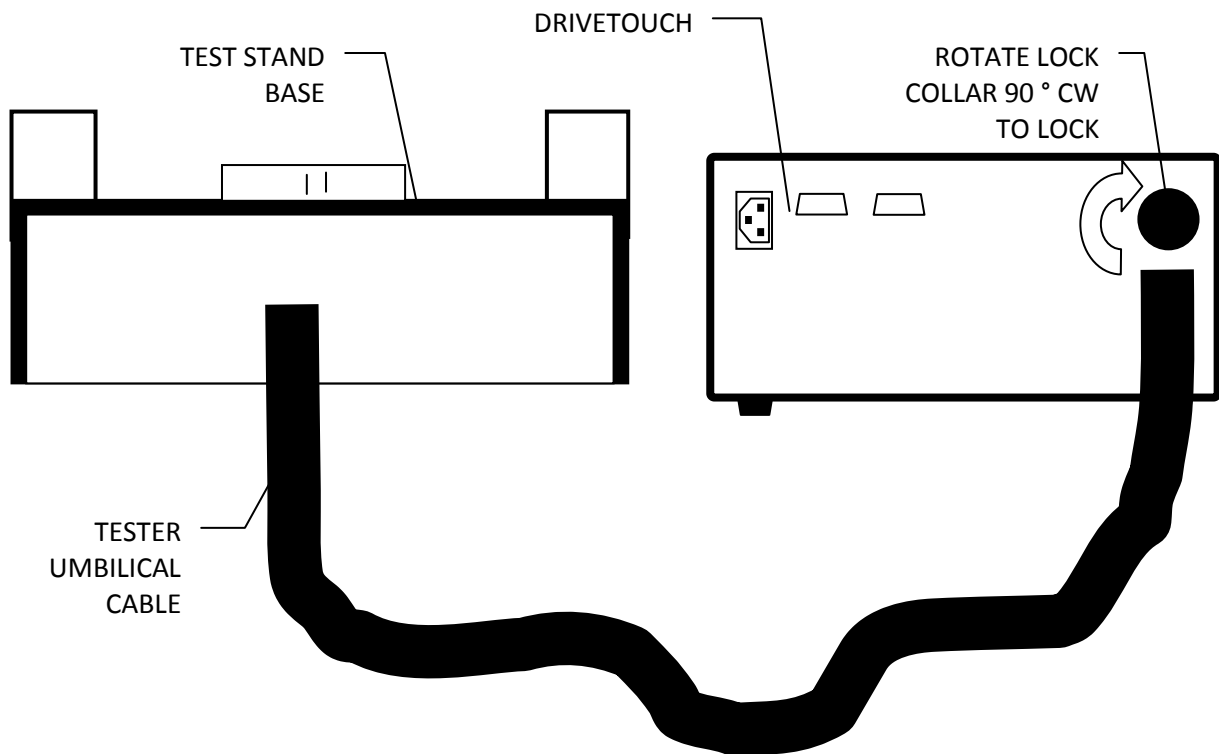

## 2. Installing the load cell

Mount the SPIP sensor on the cross head and plug its connector to the controller.  
 Take away the mechanical stop limit

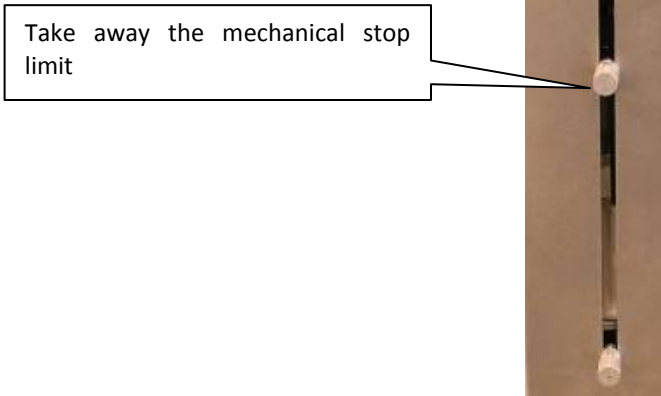

### CAUTION

THE LOAD CELL IS A PRECISION PIECE OF EQUIPMENT. LOAD CELLS, ESPECIALLY SMALLER CAPACITIES, ARE VERY SENSITIVE AND CAN BE DAMAGED OR RUINED BY DROPPING OR MISHANDLING THEM. TO AVOID DAMAGE DURING INSTALLATION, FOLLOW THESE INSTRUCTIONS CAREFULLY. REPEATED REMOVAL COULD CAUSE DAMAGE TO THE CABLE.

1. Check to make sure the power switch on both the Test Stand and DriveTouch is in the OFF position.
2. Connect the Test Stand and DriveTouch power cords to appropriate power source.
3. Make sure that the controller and tester interface cables are connected between the Test Stand and DriveTouch (See **Erreur ! Source du renvoi introuvable.**Chapter “Connecting the Drivetouch controller”).
4. Mount the SPIP load cell on the cross head of the tester. (As Load Cells are available in different sizes and shape, an adapter is sometimes used to make these parts mechanically compatible with the tester.
5. Plug it into the top of the DriveTouch controller box

## 3. Load cell - General installation guideline

Important precaution during installation: Handle the load cell with care, and make sure that it cannot be overloaded.

The forces to be measured must act on the load cell as accurately as possible in the direction of measurement. Torsional, eccentric loadings and lateral forces can produce measurement errors and can destroy the load cell if limit values are exceeded.

Screws and other construction elements must be screwed into the load cell in such a way that the construction element does not touch the measuring body (potting material).

To protect the strain gauge, the load cell is potted with a plastic material at appropriate places. This procedure offers the strain gauge high protection against environmental influences. To retain the



protective capacity and ensure permanent functionality, the load cell potting material must not become damaged.

Strain gauge installation protection – load cell range from 10N to 1000N:

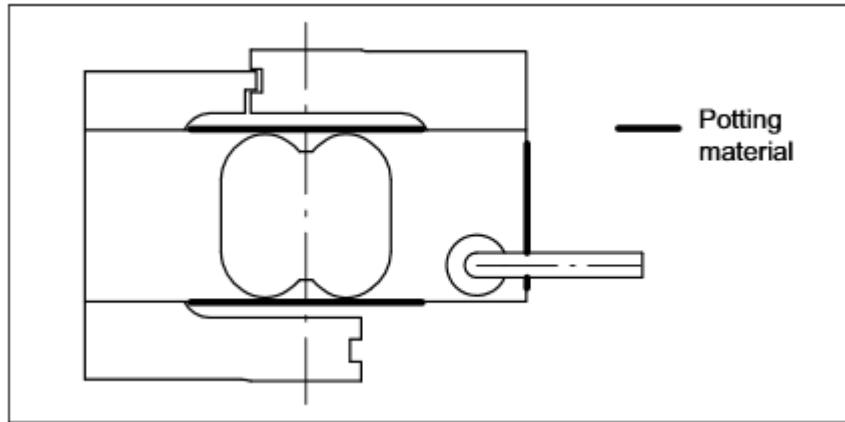

Strain gauge installation protection – load cell range from 2kN to 50kN:

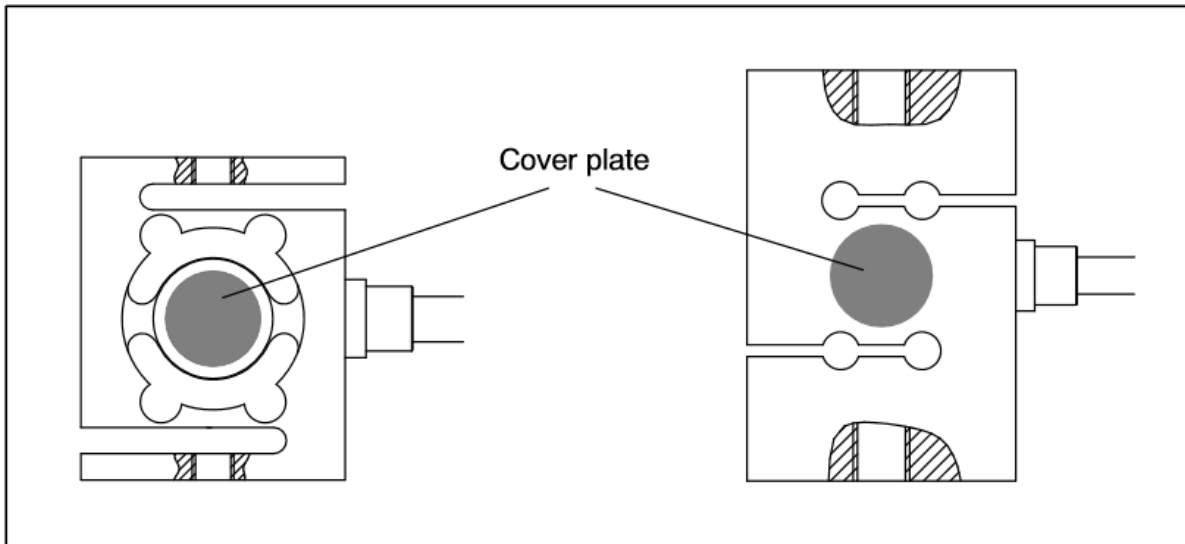

Load cell orientation during installation - load cell range from 10N to 1000N:

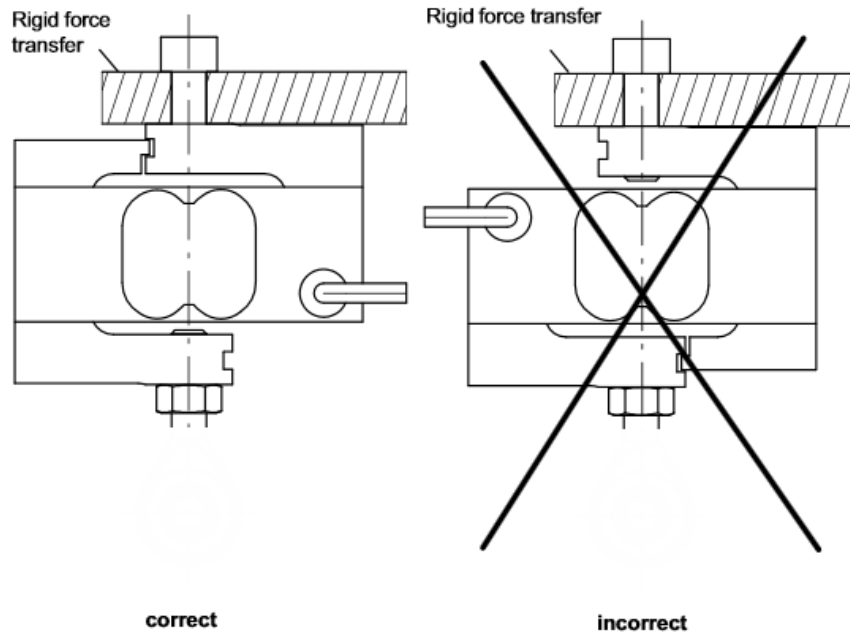

Load cell orientation during installation - load cell range from 2kN to 50kN:

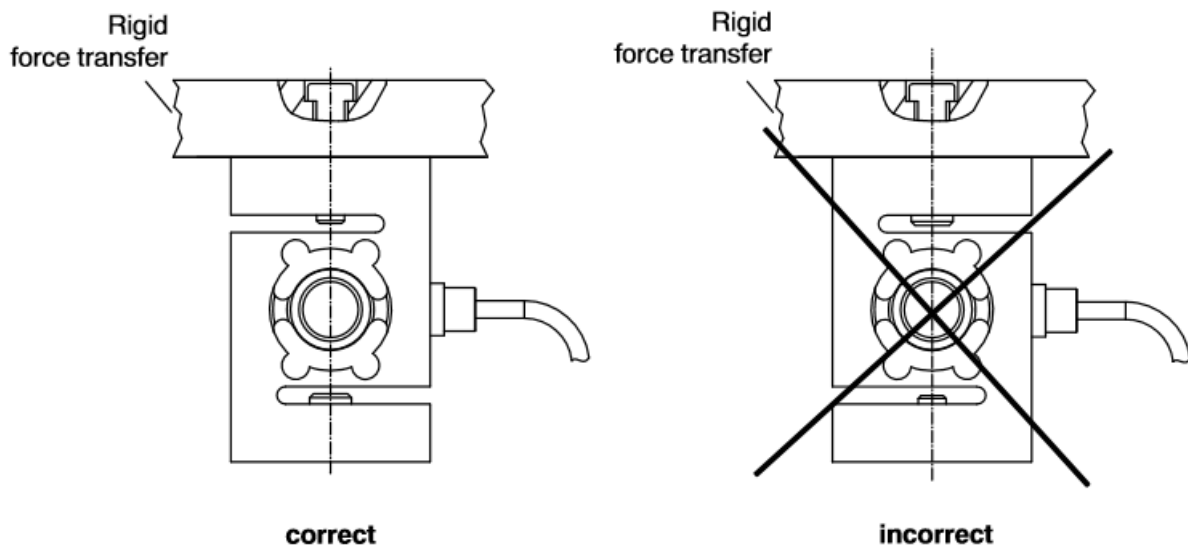

**4. Switch on**

Plug the power cord, press the ON the switch and unlock the emergency stop switches

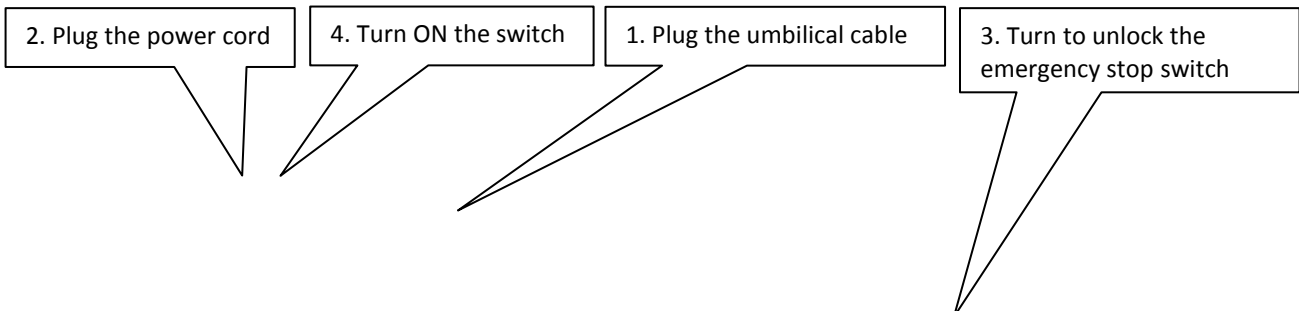

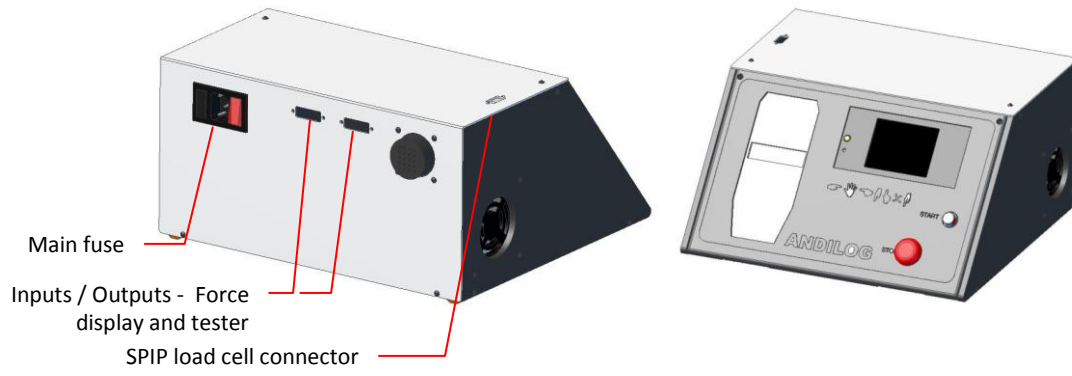

### 5. Starting your test stand

The test stand ATLAS II ST is composed by two separate commands:

- DRIVEPACK: Allow you to control the displacement of the test stand: speed, direction...
- CENTOR TOUCH DUAL: Display the measure of the force/travel and others features.

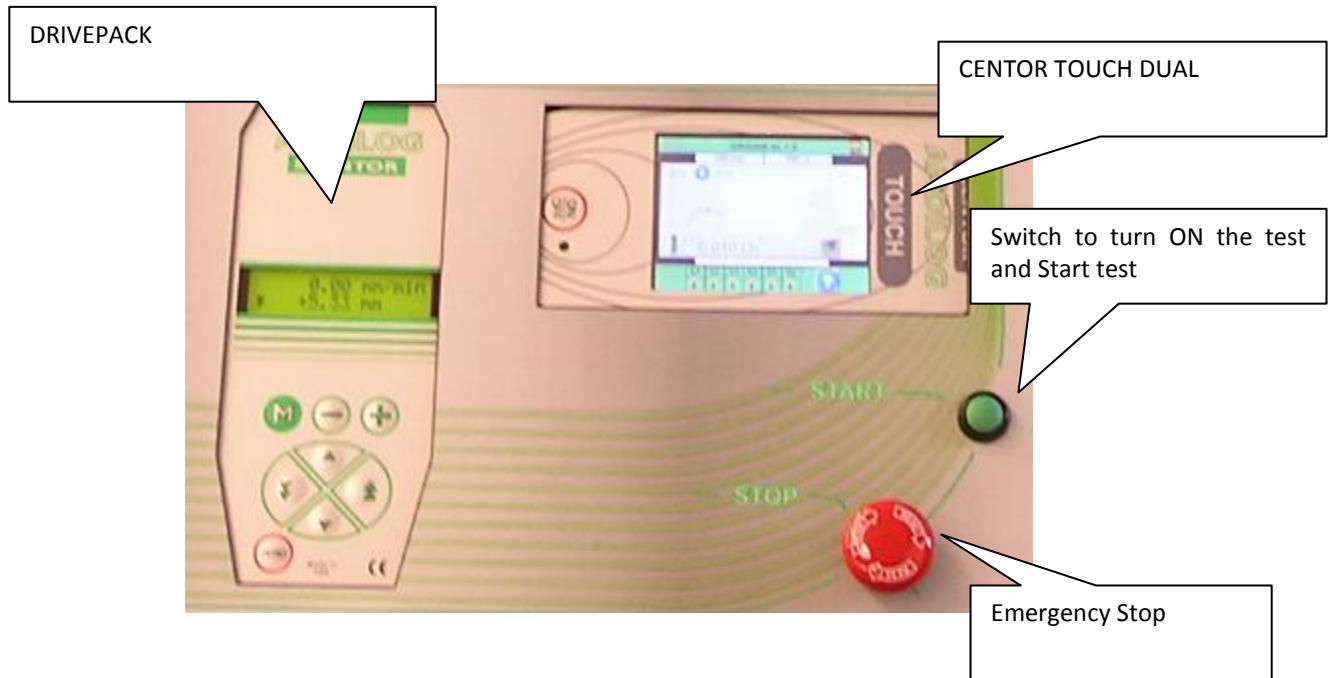

By switching ON the button on the side of the test stand and if the emergency button is not in up position, the DRIVEPACK will not turn ON.

To start the display CENTOR TOUCH, push the button ON/OFF: a general screen appears for 5seconds and then the main measure screen is displayed.

**General Screen from the force gauge:**

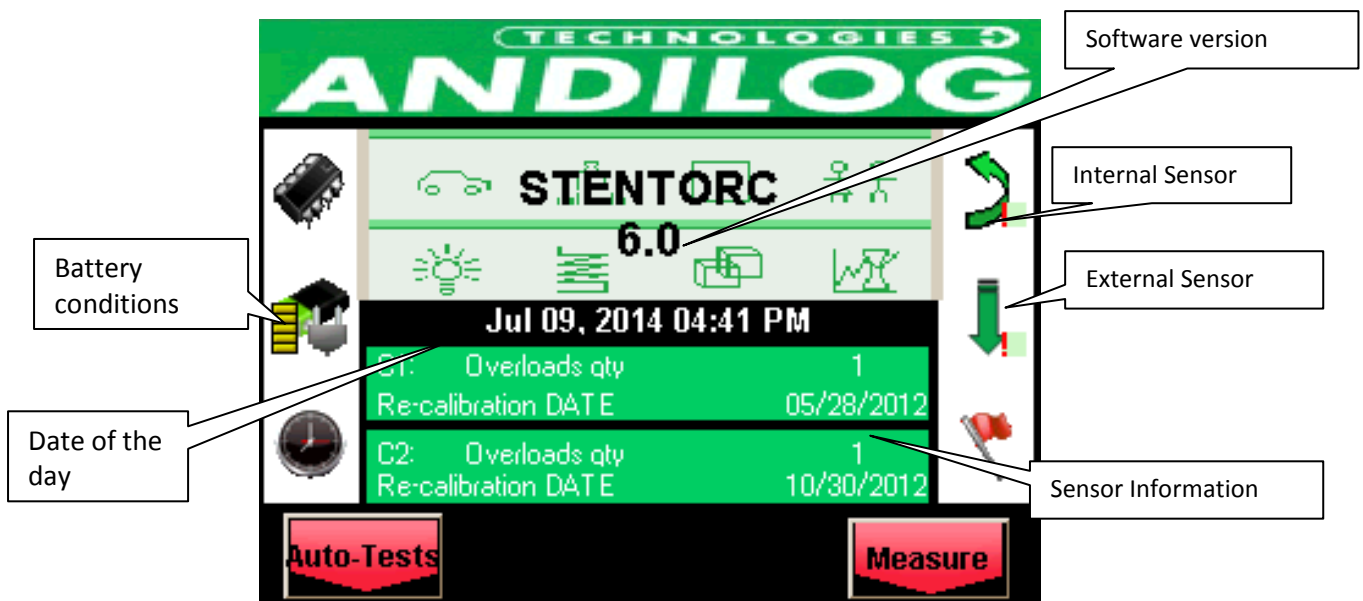

**Battery condition:** Display the battery condition

**Date of the day:** Display according to the format DD/MM/YYYY or MM/DD/YYYY can be setup in the maintenance menu (see chapter “maintenance”).

**Software version:** the line indicates the software version installed on the force gauge

**Internal and External sensor:** show the type of attached sensor (force, torque, deflection or angle) and its condition.

- A red X indicates that the sensor is not recognized or has a serious problem.
- A red exclamation point ! indicates the sensor has a problem that is not serious: An overload or calibration time past.

**Sensor Information:** The CENTOR TOUCH force gauge can detect when turned ON, whether internal or external sensors are connected. External sensors are linked to CENTOR TOUCH Force Gauge through a special connector called SPIP.

- If an internal sensor is detected AND NO EXTERNAL SENSOR IS DETECTED, the internal channel is the measuring channel.
- If an external sensor is detected, the external channel is the measuring channel.

The following information regarding the sensor is displayed:

- V1 for internal or V2 for external.
- Date of the next calibration due
- Number of overload

When the battery is low, a low battery message is displayed on the screen as the gauge is turned on, before carrying out tests.

If the charger is connected, the message « CHARG » will be displayed.

While displaying low battery indication, CENTOR TOUCH force gauge runs internal tests. If during these tests, problems are detected, the internal information screen is displayed.

An error message indicates that the force gauge is not in optimum operating condition for measuring.

---

Please see the Appendices chapter for the meaning of indications and error messages.

If the error detected makes measurement impossible (defective sensor for example), the display will hold and it will be impossible to take any further action. Then return the instrument to ANDILOG TECHNOLOGIES for examination.

If the error detected does not make measurement impossible (low battery for example) you can switch to the main screen by pressing MEASURE button.

## **6. Operating Principles of ATLAS II**

The ATLAS II ST has been developed to work with the two commands DRIVEPACK and CENTOR TOUCH separately:

- DRIVEPACK - Allows you to control the displacement of the test stand: speed, direction...
- CENTOR TOUCH DUAL - Displays the measure: force/displacement and others features.

Those two systems are setup separately however they are communicating one with another, using input/output called TTL.

The main operating principles are the followings:

- Using the DRIVEPACK you can configure: the up and down speeds, the travel limit, mechanical stop limit, cycles and the actions of what to do when the stand cross a stop limit.
- Using the CENTOR TOUCH you can configure the acquisition of the force / travel, the calculations (break force, average...), force limits.
- You can setup the Centor Touch outputs for the DRIVEPACK to do some specific actions (stop, return...) at a certain times of the test. The main configurations are explained on the next chapters, as by example: Stop on limits, return on break calculation, topload test...

This operating manual is organized with the same principles. We will see first « how to configure the travel of the motorized test stand, then how to configure the force acquisition and finally the communication parameters between both systems.

In the last chapter some setups are explained more in deep.

### 3. Displacement of the ATLAS II

The displacement of the test stand is done through the command DRIVEPACK, shown below.



#### 1. Remote control

The keys of remote control have different features depending of the run mode of the ATLAS. There are two run modes described below:

- STANDARD
- SETUP

#### 1. Running in STANDARD Mode

KEY #	NAME	DESCRIPTION
0	Screen	Gives information regarding the status of the ATLAS. Shows displacement value, speed value, test in process, error messages, etc
1	MENU	Access to the SETUP Mode
2	+ Button	No function
3	- Button	No function
4	Up Button	Start up travel at the preselected speed setting

5	Down Button	Start down travel at the preselected speed setting
6	Up high speed button	Start up travel at high speed
7	Down high speed button	Start down travel at high speed
8	Reset	Reset the travel value if the motor is stopped

***IF THE MOTOR IS RUNNING, PRESS ANY KEY TO STOP THE TEST STAND***

## 2. Running in SETUP Mode

KEY #	NAME	DESCRIPTION
1	MENU Button	Access to STANDARD Mode and save data
2	+ Button	Go to the next parameter
3	- Button	Go back to the previous parameter
4	Up Button	Increase parameter value by 1 unit
5	Down Button	Decrease parameter value by 1 unit
6	Up high speed Button	Increase parameter value by 100 unit
7	Down high speed Button	Decrease parameter value by 100 unit
8	Reset	No function

**NOTE:** When the motor is stopped, you can reset the displacement value to zero by pressing the Reset key. This makes the displacement origin relative.

## 3. Emergency Stop

The ATLAS test stand has a power emergency stop switch on the right bottom of the cover. This emergency stop turns off all power to the test stand. To restart the ATLAS, you must unlock this switch by rotating it clockwise.

**Note:** If you stop the ATLAS with the emergency stop during a test, it is possible that the displacement value was not saved correctly. You must check this value when you turn on the ATLAS after an emergency stop.

If the motor is off when you use the emergency stop to turn off your equipment, the displacement value is saved correctly.







## 2. Travel Settings

The DRIVEPACK allows you to configure the up and down speed of the test stand. The up and down speed can be managed separately. For each direction you can setup the following parameters:

- Speed
- Travel limit
- Action after reaching travel limit
- Action after reaching mechanical limit
- Time of travel
- Action after reaching the time of travel
- Cycles

To navigate in the menu and to go through one parameter to another, you have to use the following process:







- To access to the main Menu, press the button .
- To navigate from on menu to another, press the button + and -
- To exit from the Menu and save the configuration, press the button .
- To change parameters value (increase or decrease value) press the buttons , , , .

### 1. Architecture of the menu

- Speed - Up
- Speed - Down
- Mechanical sensor limit - Up
- Mechanical sensor limit - Down
- Travel Position limit – Up
- Stop specification (fast or precise)
- Travel Position limit – Down
- Stop specification (fast or precise)
- Time Stop - Up
- Time Stop - Down
- Pause time - Up
- Pause time - Down
- Cycles
- Foot Pedal Action
- Input 1
- Input 2
- Output
- Units
- Language

The menu is dynamic; it means that if a limit is inactive, then its menu is not displayed in the DRIVEPACK.

### 2. Speed Configuration

The first two menus are to setup the up and down speeds. These two speeds can be managed separately. Use the  &  keys to increase or decrease the value by 0.05mm/min and the  &  keys to increase and decrease the speed by 5 mm/min.

**Note:** When the test is running and specially for compression tests, a high speed configuration can enable the security system of the sensor (security system based on the maximum capacity).

### 3. Limits stop

A limit stop is a fixed point on the column where the crosshead is going to stop during travel. The “top limit stop” is the limit stop linked to the up travel and the “bottom limit stop”, is the limit stop linked to down travel.

If several limit stops are activated, the first limit stop the crosshead meets will stop the tester. This means that all the other limit stops in the same direction will be ignored.



There are 3 different limits stop on the DRIVEPACK: Mechanical sensor, travel position and time. For each ones you can select 4 actions:

- Inactive : the test stand doesn't take this limit into account
- Stop : The test stand stop when it reaches this limit
- Inverter : the test stand stop and moves in the opposite direction at the preselected speed
- Delayed Inverter : the test stand stops and moves in the opposite direction at the pre-defined speed after a time defined in the menu "Pause"

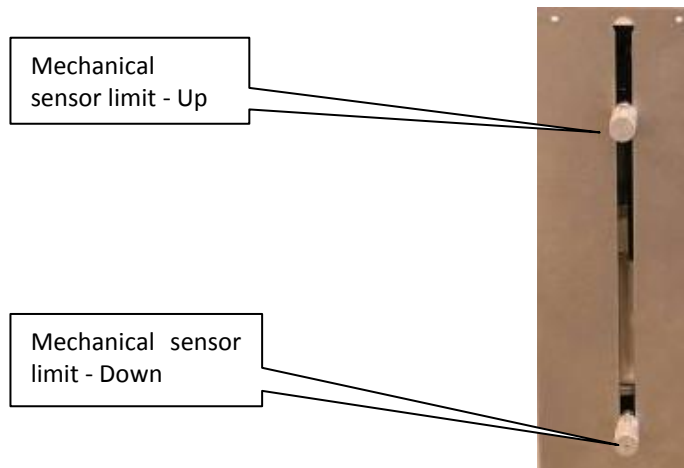

You can configure multiple limits for the same test. It is highly recommended to use the mechanical sensor limits as security limits stop to avoid sensor or sample destruction. Therefore the travel limits and time limits are usually used to end the test.

**Mechanical limits:** There are two mechanical sensor limits on the side of the test stand as shown on the picture below. There are usually used as security. It is highly recommended to have them always active.









You can configure those limits separately in the menu « sensor  ” and “sensor  ”.

Note: These limits are also active in high speed displacement.







**Travel Position limits:** The position limits are defined by displacement in millimeters. These limits can be active or not. The displacement value and the actions are available in the menus “Pos. stop  ” for the up travel and in “Pos. stop  ” for the down travel.

Note: The value for this displacement is relative to the 0 position of the frame and this relative position can be tare at any time using the key  . The up travel is positive and the down travel is negative.



For example, if you put the following parameters:

- Speed  150 mm/min
- Speed  50 mm/min
- Pos Stop  STOP
- Pos stop  60mm
- Pos Stop  Inverter
- Pos Stop  -30mm
- All other limits aren't active



Now, if you go back to the STANDARD mode, there are two possibilities:

- Push on the  key to tare the displacement of the test stand and then the  key: The ATLAS is going to move down 30mm at 50mm/min. Then stop and move up 90 mm (30mm + 60mm) at 150 mm/min and then stop
- If you DON'T push the  key, if the position value on your ATLAS is for example +10mm and then you push the  key: The ATLAS is going to move down of 40mm (+10 – (-30)) at 50mm/min then stop and move up 90 mm (30mm + 60mm) at 150 mm/min and then stop
- Push on the  key to tare the displacement and then the  key: The ATLAS is going to move up 60mm at 150mm/min and then stop.

**Note:** The up and down travel position limit stops DON'T work if the ATLAS is in high speed mode

**Time Stop:** The time stops are defined by a time of travel in seconds. These limits can be active or not. The time and the actions are available in the menus “Time stop  “ for the up travel and in “Time stop  “ for the down travel. The principles of configuration are the same as the Travel Position limits.



**Note:** The up and down Time stops DON'T work if the ATLAS is in high speed mode

**Pause:** If at least one of the limits defined previously is configured with the action « DELAYED INVERTER » then the menu “Pause  » and « Pause  » are available. Those menus define the time the ATLAS is going to stop when it reaches one of the stop limits before moving in the opposite direction.

**Cycle:** If at least 2 stop limits are set on “inverter” or “delayed inverter”, then the menu “cycle” is available. Define the number of cycles (between 1 and 255) the ATLAS is going to perform when it reaches up and down limit stops configured in “Inverter” or “Delayed Inv”.

### 3. Start a Test

You can start the displacement of the test stand using two different ways:

- Pushing the key  and  to go down or up.
- A long press on the Green button on the front of the ATLAS will also start the displacement of the ATLAS. This green button can be configure according to your needs please see the following indications.

**Green button configuration (in Front).** To configure the action of the button selects the menu “Foot Pedal Action” in the Drivepack, multiples choices are possible:

- Inactive : No action
- Start Pos : The test stand moves up
- Start Neg : The test stand moves down
- Stop : Stop the test stand when the button is pushed
- ZERO :Put the position of the ATLAS to 0 (equal to the key  )

When the test is started, the DRIVEPACK displays:

- Speed of travel
- Travel direction
- Relative position in real time of the test stand

Example:



↑	100.0 mm/min
+	12.00 mm

In this example, the test stand is moving up at 100mm/min and its position is +12 mm above the point 0.00mm.

To stop the ATLAS, press any key on the DRIVEPACK.

**Note:** If the ATLAS reaches any limit stop during its travel, it will execute the defined setup (for example Inverter or Stop).

#### 4. High Speed Travel



It is possible to move the crosshead of the test stand at the high speed manually by using the key  and  to go up or down as required. The ATLAS starts to move in the selected direction at the high speed value (350mm/min) and will continue to move as long as you press the key.

**Note:** In high speed travel, only the Mechanical limit sensors are active. The other limits are not active. This mode must not be used to run tests.

#### 5. Reset the position

To set the position of the ATLAS to 0.00mm, press the key  when the motor is stopped.

#### 6. Units

The menu allows you to choose the speed and displacement units. Use the key  and  to change from mm/min to in/min.

#### 7. Change the language

The last menu allows you to change the language of the DRIVEPACK. You can choose between:

- French
- English
- German
- Spanish

## 8. TTL Input of the Drivepack

The Drivepack has two TTL inputs. They are connected through the 15 pins connectors on the side of the test stand, and allow you to connect the tester to an external device in order to program actions. (See appendix for pin numbers details). By example you can program the tester to stop when it reaches a load value or detect a setpoint.

These two inputs are connected to the Output 1 and Output 2 of your Centor Touch Dual display (setup a stop action of your test stand on break detection by example using inputs from the Drivepack and output from the Centor Touch).

Here are the available actions:

- Inactive : No action
- Start Pos : The test stand starts moving up
- Start Neg : The test stand starts moving down
- Stop : Stop the test stand when he is moving
- ZERO : Tare the displacement value of the test stand (equal to the key )
- Inverter: The test stand start moving in the opposite direction
- Delay inverter: The test stand start moving in the opposite direction after a pause time (define the time in the pause menu).
- RS232: the DRIVEPACK is sending the message "Input TTL" on the RS232 for the software CALIFORT. If you are not using the software CALIFORT, it has no action.

## 9. The TTL Output of the Drivepack

The Drivepack has TTL outputs that can be set, available through the 15 pin connectors on the side of the DriveTouch controller, in order to inform another device of an event. The different events are:

- Inactive: the output is disabling
- Stop limit up: from mechanical, position, time...
- Stop limit down: from mechanical, position, time...
- Error: security error, motor error...
- End of the test: end of test under cycle mode

## 4. Measuring with the ATLAS

Once you have set the displacement of your ATLAS according to your needs, you can now setup the CENTOR Touch Dual that allows you to perform your force measurements.

After turning ON the Centor Touch Dual you must be on the main measurement window with the display of the curve and measurement results

### 1. Main measuring display

After the starting screen, you will have access to the main measurement screen as shown below. Depending on the configuration of your Centor Touch, some information can be displayed or not.

**Note:** the described parameters below are part of the default configuration

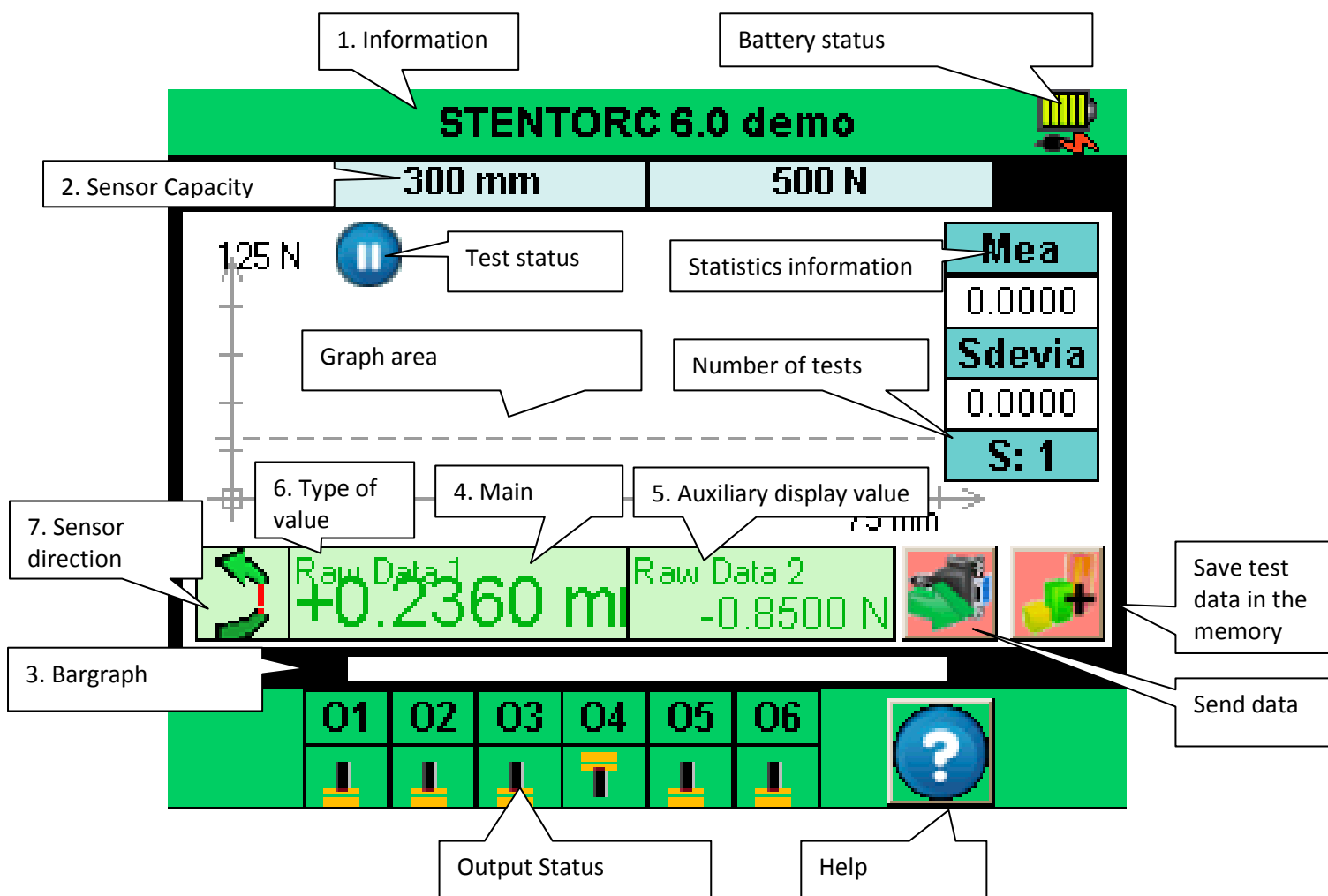

1 - Information: the version and type of the display is shown in this bar as well as the battery indicator: pictogram indicating the battery power status via 4 horizontal lines which respectively symbolize 25%, 50%, 75% and 100% of power... If you press his information bar, you will have access to the main menu.

2 - Capacity of the sensor: this is the maximum capacity of the load cell mounted on the stand and the measuring unit.

3 - Bar graph: A black line is the representation of the applied force. If the bar graph is full, it means that the sensors maximum range is reached: risk of overload!



If the thresholds are activated, the bar graph color changes based on the current force reading.

4 – Main display: Many values can be displayed in this window: current reading, peak, minimum, calculation.... See chapter on display setup for more information.

5 – Auxiliary display: Many values can be displayed in this window: current reading, peak, minimum, calculation.... See chapter on display setup for more information.

6 – Type of values: Displayed on the top left of each value, it indicates the type of value displayed: current reading, peak, calculation...

7 – Sensor status: An easy-to-remember small symbol indicates the direction of the force exerted on

the sensor:  for tension and  for compression.

## 2. The different tactile area of the display

Each area of the display can give access to different menu of the ATLAS II:

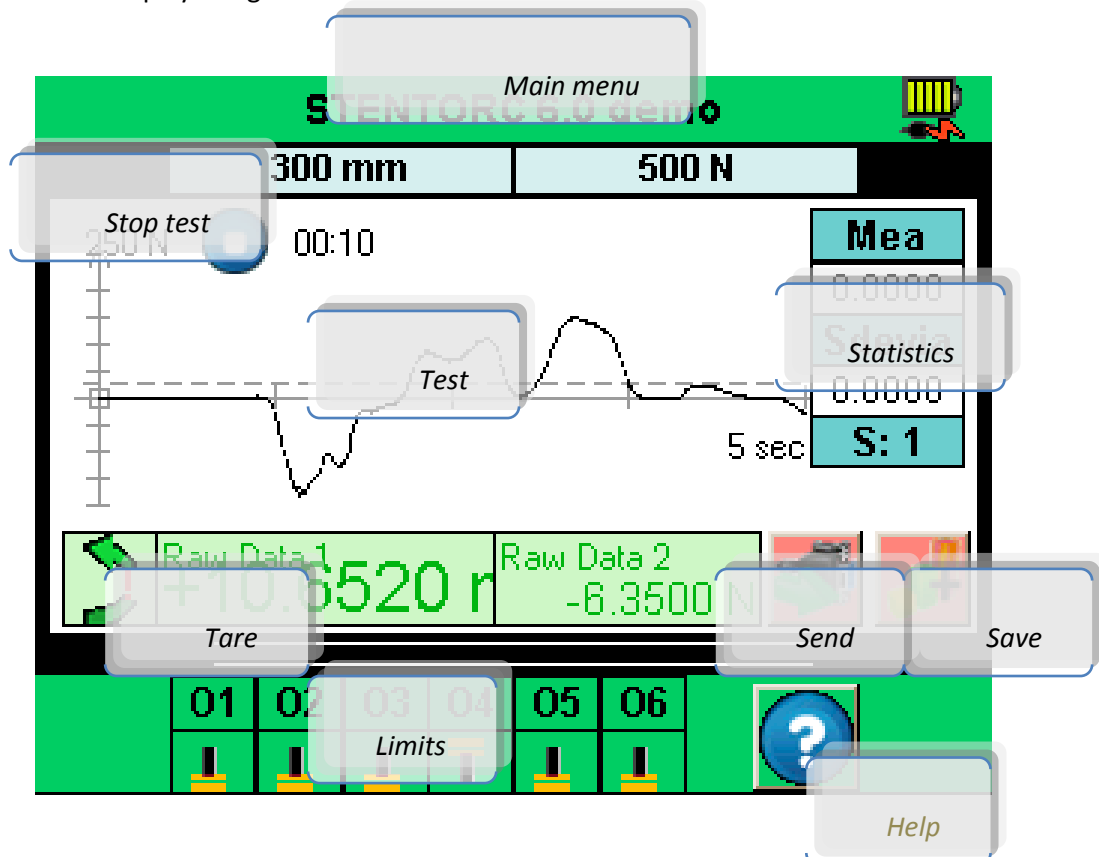

### 3. Main menu

To go to the main menu, press the green bar at the top of the display. Then you will see the following window:

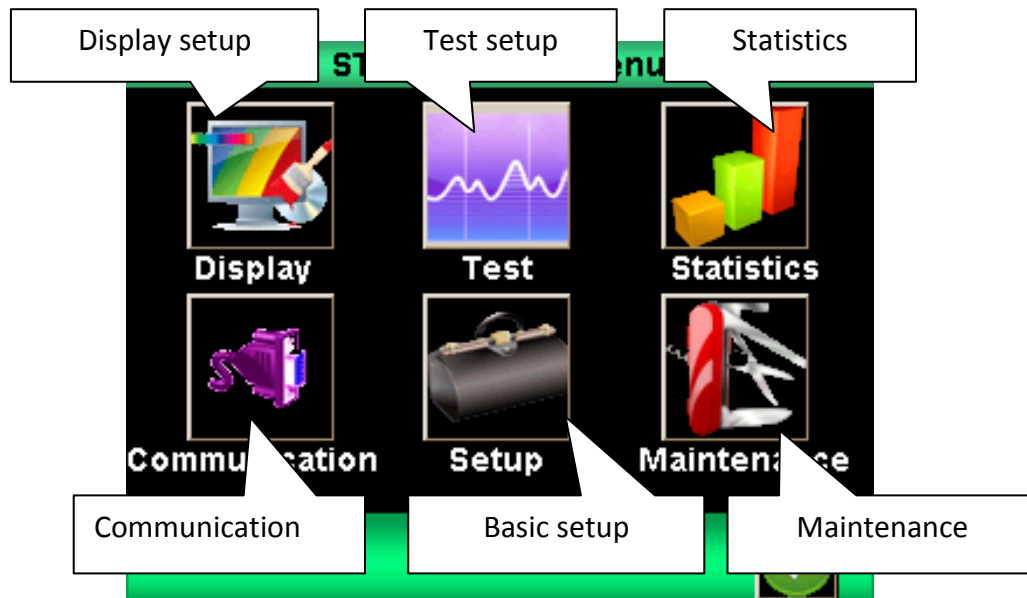

### 4. Zero or Tare

**Before each measurement, it is important to zero or tare the test stand.** In the default setup, the green button on the front panel of the ATLAS II is setup to tare and zero the test stand and start a test. It is also possible to tare the stand before a test by pressing the Tare area on the main measuring display.

The test stand will take into consideration the weight of accessories (hook or plate) fixed on the sensor’s adapter. In order to be able to zero the load cell, the total weight of the accessories must not exceed 10% of the full capacity of the load cell. Taking this action resets all memories, peak values, calculations and TTL input/output.

**NOTE:** When turned ON the CENTOR TOUCH completes several self-tests to check the sensor’s health. It is possible to leave tools fixed on the force gauge, but the total weight must not exceed 10% of the sensor’s maximum capacity.

### 5. Backlight

When using the test stand, the backlight automatically turns off after a preset time of operation. The total battery life the CENTOR TOUCH will be reduced when the backlight is turned on.



## 5. Your first measurements

In the default configuration, the ATLAS II is setup to display the curve of the test. You should have the following display when the stand starts:

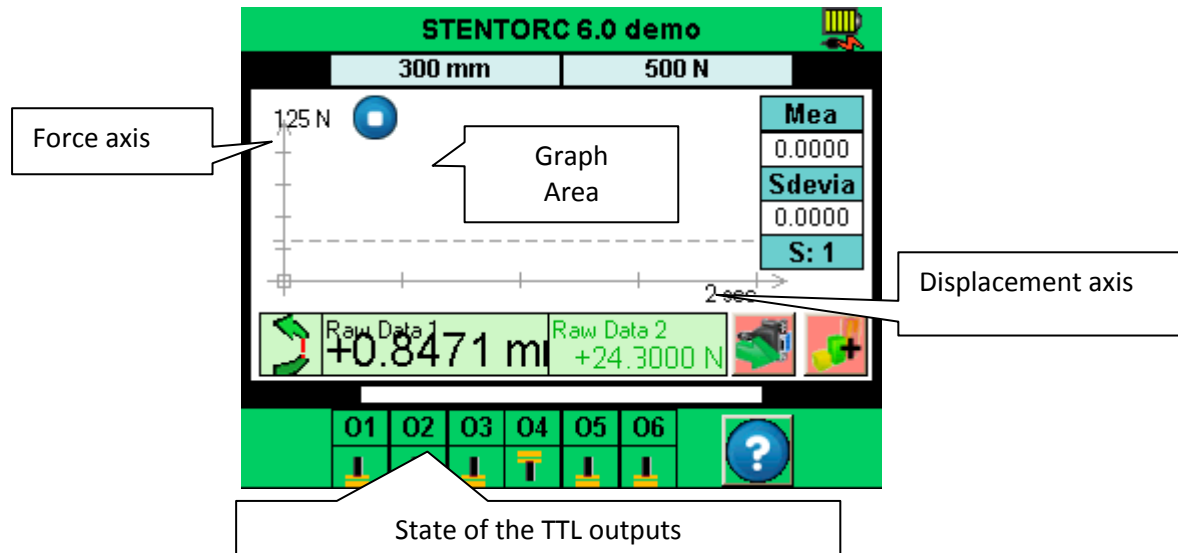

### 1. Start measuring

In the default configuration, the ATLAS II will display the curve of force versus deflection. To start a measurement, you just have to press the green button Start for 1 second on the front panel. Then the ATLAS II will tare the force, zero the deflection and the test stand will start moving based on the setup of the Drivepack.



The curve of force versus deflection will start drawing on the display when the force increases.

The graphing area is self-adjustable during the test. There are 3 values for the scale of the graph: 25%, 50% and 100%. At the end of the test, the graph will be automatically adjusted to use all the display. The measured values can be positive or negative.

### 2. State indicator

On the top left corner, there is a state icon indicating the current operation on the ATLAS II:



The system is waiting, the curve has not started yet but the tare is done



The system is acquiring data; the display is drawing the curve.



The test is ended. To start a new test, you must Tare the system.

If you want to stop a test before the end of the time of the test, you can press this icon. It will change from acquisition to stop. **Warning: Please note that this operation does not stop movement of the test stand.**

### 3. Curve area

There are 3 possibilities for the position of axis: positive, negative, positive/negative. The graph will self adjust depending on the values measured.



To start drawing a curve, you must first press the Start green button or Tare the stand using the display. When the ATLAS II detects a force increasing, it will automatically start drawing the curve.

The curve shows the force applied on the load cell versus deflection. In the main display area, the ATLAS II displays the current force reading. The deflection is displayed in the auxiliary area. This setup can be modified in the Display menu.

The ATLAS II has a high speed acquisition rate of 500Hz on force and deflection. Nevertheless, for a better reading, it keeps in memory only 1000 data points to draw the curve.

If you want to have a graph with more data points, you can download directly the values to a computer using:

- The RS232 output with 100 data points per second
- The USB output with 1000 data points per second

At the beginning of the curve, the state indicator will change from  to . To stop the acquisition, you can press the graph area. Nevertheless, the test stops automatically after the time setup for the test., see chapter 4 part C.

At the end of the test, the state indicator becomes .

You can then:

- Read the graph
- Save the calculated values (peak, calculation...) by pressing the Save area
- Download the calculated values to a computer using the RS232 output by pressing the Send area
- Modify your configuration
- Erasing the graph and start a new test by pressing the main display area or the green button the front panel.

## 6. Setup the display

You can access this menu by pressing the green bar at the top of the measuring display. Then press the first icon on the top left of the main menu.

You will have the display which is on the right below. Each parameter changes a setup on the main measuring display.

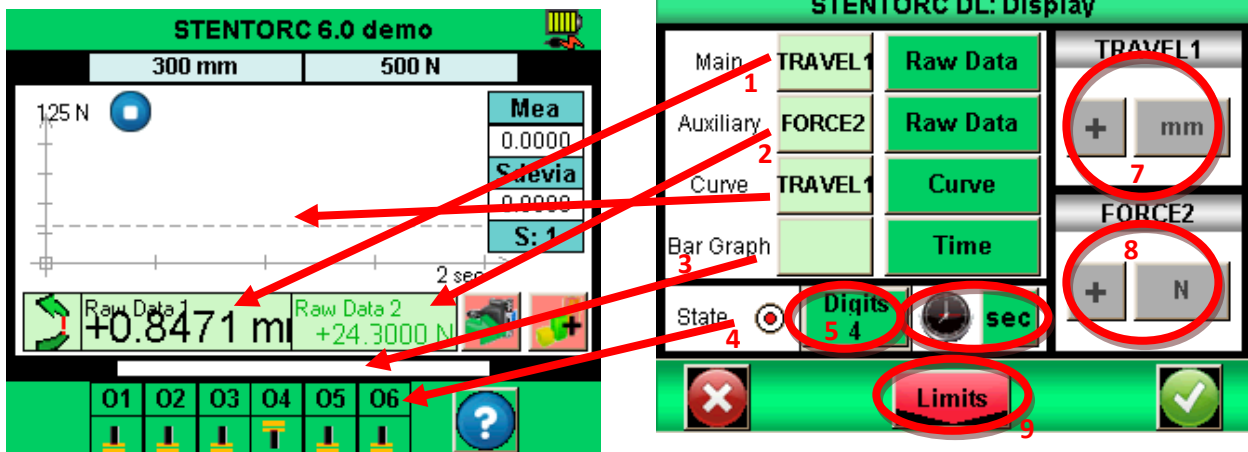

1. Main: The main area can display all the values shown on the list. Choose the sensor you want to display by pressing the green area on the left of the list. (TRAVEL1: deflection or FORCE2: force).
  - The data available in the list are: raw data, Peak, Minimum and Calcul1 or calcul2 (if calculations are activated, see « chapter VII – Setup calculations » for the different calculations available).
2. Auxiliary: same as Main
3. Bar graph: Setup for which value and sensor the bar graph will vary.
4. State: to display or not the state of the output on the measuring display
5. Digits: number of digits displayed for the measure between 0 and 4.
6. To change the time unit for the duration of the tests by pressing the green area. The units available are millisecond, second and minute.
7. Unit and sign of the deflection: positive, negative or no sign
8. Unit and sign of the force: same as deflection
9. To do to the threshold menu, see « chapter V – Setup limits ».

## 7. Setup limits

You can access the limit menu by pressing the bar graph on the measuring display or thru the Display menu with the button on the bottom of the display. The limit feature of the ATLAS II is designed to perform different actions when the force value reaches the limit... Those actions can be: changing color of the value on the measuring screen, activate a sound, stop the stand...

### 1. Activate / Deactivate

Press the area « Touch to Active! » or « Touch to Deactivate! » To activate or deactivate limits.



### 2. Sensor tab

You have two tabs available, one to setup a deflection limit and one to setup a force limit... You can setup separately each sensor (force and displacement). Select the tab you need. Then press the area to activate or deactivate the limits.

### 3. Choose the type of value

It is possible to define what type of value you want to use for the limit. Most of the time, the current reading is used. Nevertheless, it is also possible to setup a limit on a peak value or a calculation (average, break...) see « chapter VII – Calculations setup »).

Through the drop-down menu, select the data on which the limit must be set

### 4. Setup the limits

You can define a bottom and a top limit for each sensor pressing the corresponding area. Then type the selected value using the keyboard.

You can then select to have a buzzer or not when the stand reaches the limit...

The limit values will be automatically displayed on the graph and bar graph during the test. The color of the current reading will change when the sensor reaches the limit.

### 5. Stop the test stand with a limit

You can stop the test stand when it reaches a force limit. First you have to setup a limit value. Then you must activate one of the outputs of the Centor Touch (O1 or O2) to send the signal to the Drivepack to stop. Finally you have to modify the setup of the Drivepack to Stop on Action Ext 1 or 2 depending on which output you have chosen on the Limit Menu (O1 or O2).

Example:

- If the bottom limit is the only value setup, the output will change when the force is over 40N.
- If you have a bottom and a top limit set, the output will change when the force is between the two values.

Example to stop on a force of 40N:

Centor Touch dual setup:

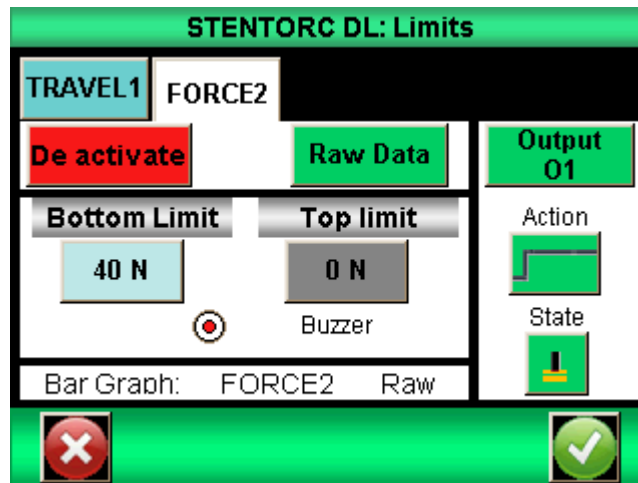

Drivepack setup:

Action Ext. 1  
 Stop

## 8. Setup test and graph

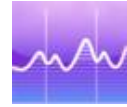

To setup the test parameters and the graph, in the main menu press the following icon:

**YOU HAVE THE FOLLOWING DISPLAY:**

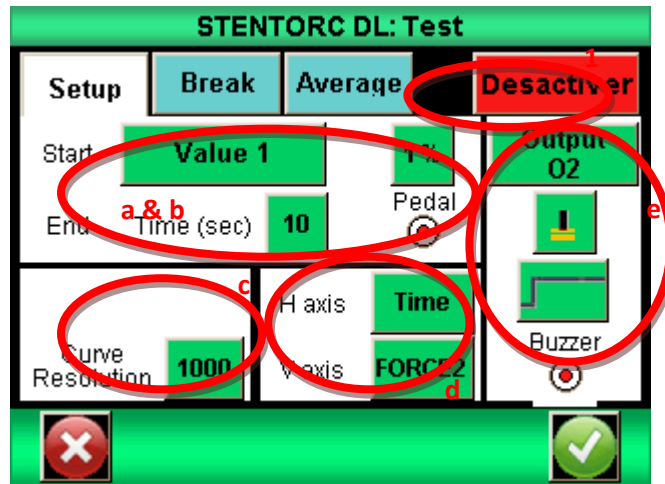

### 1. Test tab

Press the tab on the top left to activate or deactivate a test and the graph.

### 2. Setup a test

There 2 parameters to take into account to setup a test:

- The Start condition
- The duration of the test

#### 1. Start condition

When the test stands tares, it is waiting for an event to start the acquisition. There are 3 types of events:

- Variation on one of the two sensors (force or displacement)
- External action (TTL input of the gauge or pedal)
- Trigger

Choose the start condition using the list (Value 1 for displacement, Value 2 for force or trigger) or by selecting 'the red dot' behind the word Pedal (enable the START green button of the test stand ATLAS)

If you have chosen Value 1 or Value 2, you must setup a percentage of the full capacity of the sensor which will start the acquisition. For example, if the force sensor has a capacity of 100N and percentage is setup on 1%, the graph and test will start when the force reach 1% of 100 N is 1 N. Touch the green area and use the keyboard to setup the percentage value.



## 2. Test end

You must define the maximum duration of your test in order to save the data during the test. The duration of the test will influence the resolution of the curve. For example, if you have defined duration of 10 seconds and the resolution of the curve is 1000 data points, you will have a data point every 0.01 second.

Setup the test duration pressing the green area on the right of Time. Then enter the value using the keyboard.

Note: A test can be ended before the end of the duration setup using the icon  during the test or using a TTL input. Nevertheless, this stop before the end of the test will not change the resolution defined at the beginning. There will be less data points in the memory. For example, if the duration is 10 seconds and the resolution 1000 data points, you will have a data point every 10ms. If the test is ended after 5 seconds, you will 500 data points for the curve. And resolution will remain 10ms.

## 3. Curve resolution

The resolution of the curve can be changed. The default value is 1000 data points. This value is not just a data acquisition rate. In fact, the data acquisition rate is 5000Hz on the sensor, so in order to have only 1000 data points, the Centor Touch Dual averages all of the values read on the sensor and save this value to display the curve.

Example: Resolution the curve 1000 data points, duration of the test 10 seconds. Meaning one value every 10ms.

The Centor Touch Dual is going to read the value on the sensor and average all those values with a period of 10ms. So the first value saved will be the average value between 0 and 10ms, the second value between 10ms and 20ms...

## 4. Axis

You can choose what type of value on the horizontal vertical axis: time, deflection or force. Press the green area to change the type of value.

## 5. Action at the end of the test

At the end of each test you can setup the ATLAS II to do two types of actions:

- Sound: Activate or deactivate this feature by pressing the circle below « Buzzer »
- Activate a TTL output: choose the TTL output (from 1 to 6) and the type of action: pulse or steady state as well as high or low state.

## 9. Calculations

The test stand ATLAS II can calculate automatically some values during the tests. You can setup these calculations in the menu Test. It is possible to setup two calculations at the same time. The stand will calculate at the same time the current reading, peak, minimum and two custom calculations.

### 1. Choose the calculations

You can select two calculations using the tabs in the Test menu. The Test mode must be activated to use calculations.

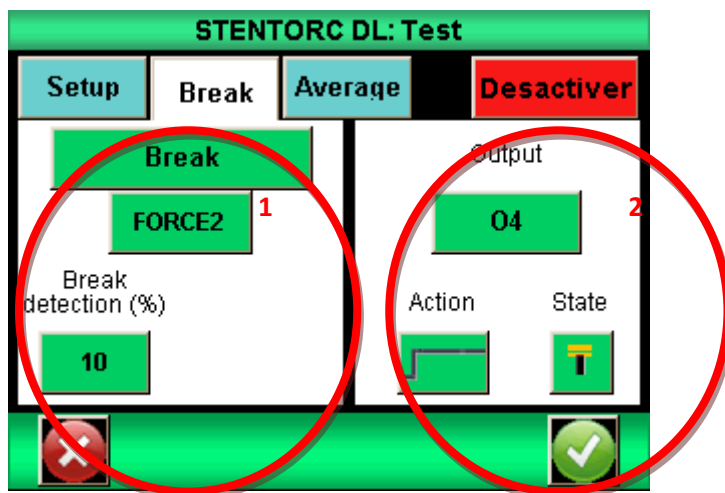

The available calculations are:



**Average:** The average of load readings over selected time or travel. Select time or travel parameters after selecting average.

**Break:** The calculated break point. Select the percent of peak to determine break point after selecting break.

**First Peak** – Selects the first peak in multiple peak graphs. Select the percent of peak to determine peak point after selecting First Peak

**Force at T** Force at a specific time. Select time in milliseconds.

**Force contact** – Calculates the maximum force when you're closing a contact or a switch plug on the Input E1 (by example a foot pedal).

**Level L** – Calculates the value of a channel, when the other one reached its defined limits (**absolute**: the time increments when the test starts / **relative**: the time increments when the curve starts, meeting the start

condition on force value, to be used for Topload tests)

**Peak** – The maximum force or torque measured during the test.

**Sleeping mean** – Moving average

**Speed:** Speed calculation in real time of the selected channel

**Stiffness:** Calculate the slope of the curve between two values

**Time of Peak:** Return the time value when the peak has been reached



## 2. Action following a calculation

After each calculation, the ATLAS can be set to do an action:

- Sound: Activate or deactivate this feature by pressing the circle below « Buzzer »
- Activate a TTL output: choose the TTL output (from 1 to 6) and the type of action: pulse or steady state as well as high or low state.

These actions are useful when you want to communicate between the motorized stand and the force reader. For example stop the test stand after break detection.

## 10. Statistics and memory

The ATLAS II has an internal memory of 1000 values per channel and calculates automatically the average value, standard deviation and the average value divided by the standard deviation. It is possible to save 3 results at the same time: peak, minimum, calculation 1 or calculation 2.

Note: It is not possible to save several curves. However you can use the optional device called DATASTICK to save all your curves or connect the test stand to your computer through dedicated software.

To activate the statistics and memory, press the following icon on the main menu:

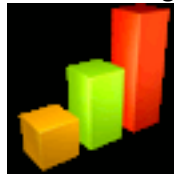

### 1. Setup

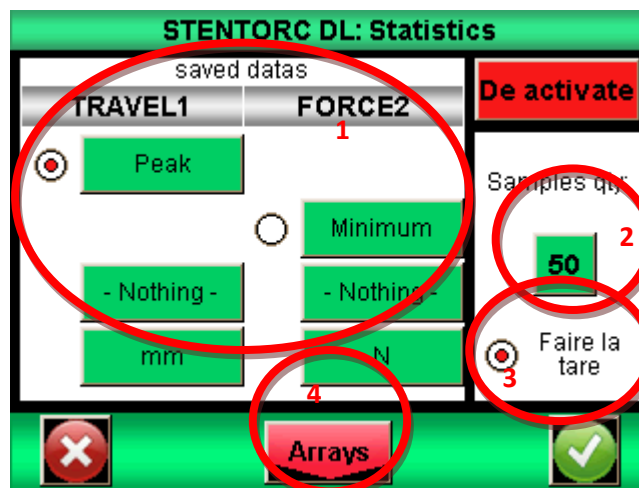

Using the lists, you can choose three values you want to save: minimum, peak, calculation 1 or calculation 2 for each channel. Then select the units.

You can also setup the number of samples that you have to test.

You will be able to view the values by pressing the button Arrays.

## 2. How to save the data

When the statistics feature is activated, the following icon is displayed on the main measuring display:



To save the data, you have to tare the gauge. At the end of the test, press the icon above to validate and save the data. The values are added to the array and the average value is calculated and displayed in the window on the top right:

<b>Mea</b>
+79.0000
<b>Sdevia</b>
+23.4500
<b>S: 3</b>

To view all the data, press this window. It is then possible to send the data through USB, RS232 to a computer or to save them on your memory USB stick. See chapter “communication setup”.

STENTORC DL: Results	
Peak TRAVEL1	Peak FORCE2
Average	+79.0000
St dev	+23.4500
Mean / St dev	3.3641
Samples qty	4



Return Array

STENTORC DL: Array		
Peak TRAVEL1	Peak FORCE2	
N	Value (N)	Date/hour
1	+47.2500	07/09/2014 05:14
2	+103.3500	07/09/2014 05:15
3	+86.4000	07/09/2014 05:15
4	0.0000	07/09/2014 05:15

Return Result

## 11. Communication

You can connect your Centor Touch to a computer through RS232, USB or Analog input, or to a memory USB stick called Datastick.

To go to the communication menu, press the following icon in the main menu:



You will have the following window:

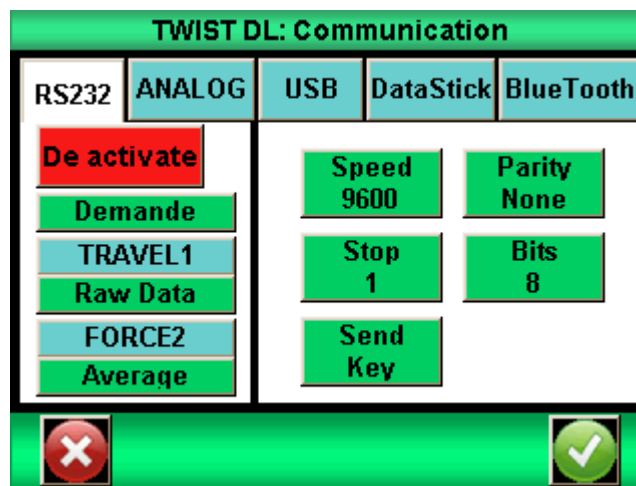

**Note:** Only one of the outputs can be used. All the other outputs will be deactivated. Select the tab corresponding to the output you want to use.

Available connection types:

- RS232: sending data continuously at 100Hz, sending data upon request via the main screen, a digital input or a computer, sending the stored curve.
- USB: sending data continuously until 1000Hz, sending data upon request via the main screen, a digital or a computer input, sending the stored curve.
- Bluetooth: sending data continuously at 100Hz, sending data upon request via the main screen, a digital or a computer input, sending the stored curve.
- Analog: sending data continuously at 100Hz
- Datastick – USB Stick (optional): sending data upon request via the main screen

## 1. RS232

The RS232 input/output can work on continuous or on demand mode:

- Continuous: Send current reading thru the serial port with a data rate around 100 Hz.
- Demand: You have to send commands to the stand to receive data. This command can be sent by a computer with ASCII characters, a TTL input or using the following icon on the main measuring display:



Note: The data displayed in the list « Send » are dynamic. So if two inputs are used for other operations, they will be displayed in this menu. Only the available inputs are shown in this menu.

Choose the type of data to send:

- If you want to send the command through a TTL input or the display, you can choose the type of data in the list
- If you want to send the command using a computer, the value sent will depends on the character sent by the computer.

Setup the speed, parity, stop bit, based on the computer connected. The default values are:

- Speed: 9600
- Parity: None
- Stop : 1
- Bits : 8

If you want to send command to the test stand you can use our optional software RSICS or use the following ASCII characters:

- F: current value channel 1
- I: current value channel2
- P: peak channel 1
- M: peak channel 2
- V: minimum channel 1
- B:minimum channel2
- C: calculation
- T: last 1000 data in memory
- U: unit channel 1
- N: unit channel 2
- W: Last curve
- Z: Tare the gauge

The following rules applied to the communication protocols on “Demand” mode:

- The force gauge doesn’t send trailing characters
- The force gauge sent the sign +, - or none according to the measured values and the settings.
- The resolution of the sent values depends of the load cell capacity
- The force and displacement values are separated by a TAB characters (09 decimal and 09 hexadecimal
- The force gauge sent the data “?” if the request isn’t valid
- The force gauge sent the data “!” if the value is empty

## 2. USB

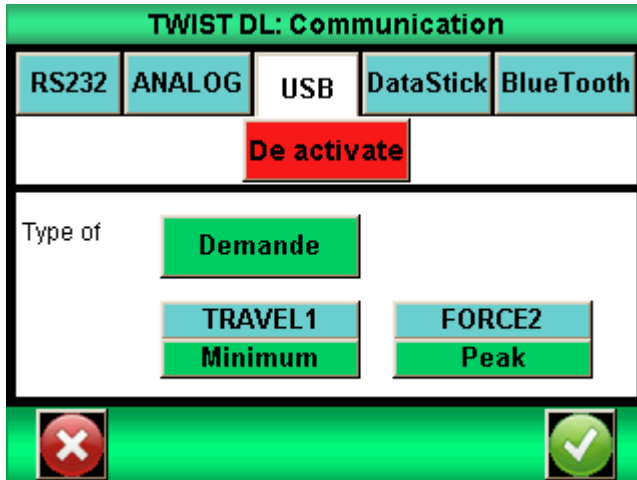

The USB is set as the RS232 communication: on demand or continue mode; and commands are similar.

However you can:

- Set the baud rate value in continuous mode if “Eco” is selected in the menu “Setup”
- The Baud rate is fixed to 921600

## 3. Bluetooth

The Bluetooth wireless communication with a computer is available, allowing replacing the RS232 or USB cable. It requires an additional optional accessory sold separately.

The Bluetooth connection has the same parameters as the RS232.

## 4. Analog

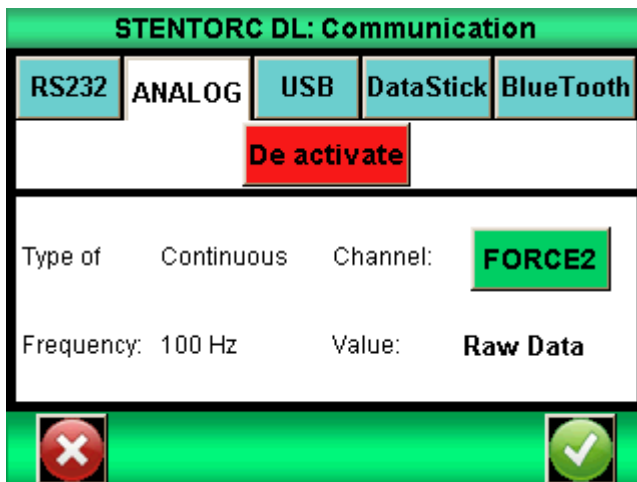

The ATLAS II can send the analog data with a data rate around 100 Hz. The output is +/- 1V.

See the appendixes for analog pins output.

## 5. DATASTICK – USB Memory Stick (optional)

### a. Presentation



The DATASTICK kit is an option available with the CENTOR TOUCH, in order to save your data on a USB memory stick.

The kit includes: a USB Stick and a connexion cable (to link the CETOR TOUCH through the 26 pins connector to the USB stick).

This feature is available for all CENTOR TOUCH from version V4.6

### b. Configuration

You can activate and configure the Datastick communication setting from the Menu “communication”

The CENTOR TOUCH is able to save several types of data on the USB stick, to choose from:

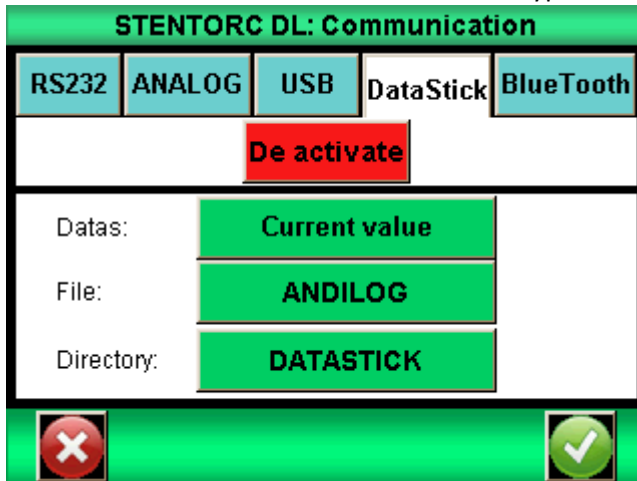

- Calculated values: max, min, and calculations selected in the menu “TEST”
- Current value: the value measured by the sensor at the time of communication.
- Curve: save the curve plotted on the screen
- Curve and calculations: the plotted curve + max, min, and calculations selected in the menu “TEST”
- Statistics: data saved in the statics table of the CENTOR TOUCH



You can change the default file name for the unitary data (statistics and values). Default file name: “ANDILOG\_date” (i.e.: ANDILOG\_20130107.txt”). Push the button to change the name. Data will be recorded at the end of this file.

The directory where the curve is saved is by default names “DATASTICK\_date\_hours”. You can change this default name by pushing the button.

The directory includes 2 files:

- Data.txt: curve data
- testSettings.txt: setting of the curve

All those files are saved as TXT format, and so can be open with regular Table software as Microsoft Excel. Data are separated by a TAB character (09 decimal and 09 hexadecimal) and the rows are separated by a carriage return (decimal 13, hex 0D).

**c. Save your data**

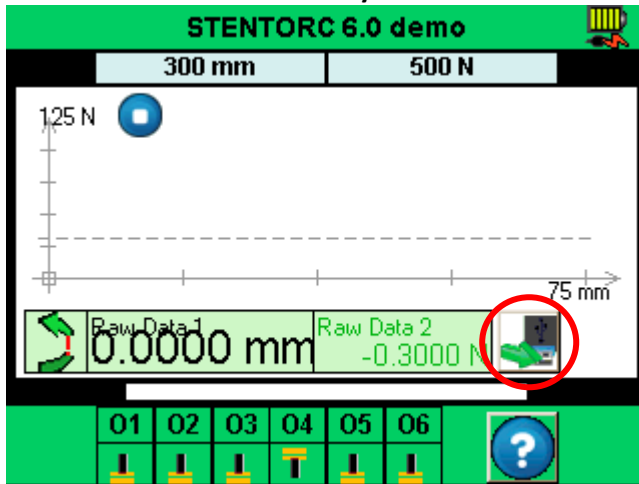

Once the DATASTICK communication is active, a USB icon appears on the main Measure screen:

Save you data on the USB by pushing on the icon:

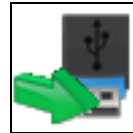

During the data transfer, the USB icon becomes a timer; do not disconnect the USB

stick at this time. Once the timer disappears you can disconnect the USB stick.

**d. Use multiples USB stick**

The USB stick supplied by ANDILOG at the time of the purchase of the DATASTICK option, has been set to communicate with your CENTOR TOUCH; and it recognize the serial number of your CENTOR TOUCH. However you can duplicate this USB sticks as many as you want. To do so: copy and paste the file "datastick config" (saved on the original USB stick) on your own USB stick.

## 12. TTL input / output and foot pedal

The Centor Touch Dual has TTL inputs and outputs which can be setup to communicate with the Drivepack or an external device.

TTL inputs and output available:

- 3 inputs (Pedal, I1 and I2)
- 6 outputs (O1 to O6)

The Drivepack has:

- 2 inputs
- 1 output

Each input and output can be setup separately using the different menus of the Centor Touch Dual shown in the previous chapter. One menu is available to display and setup all the inputs and outputs. This menu is in the menu Maintenance in the main menu. Then select the third tab « E/S TOR »:



### 1. Outputs of the Centor Touch Dual

Each output from 1 to 6 can be setup separately. The different features available for the TTL outputs are:

- None: no action
- Calcul 1: change the state of the output at the end of the first calculation
- Calcul 2: change the state of the output at the end of the second calculation
- End : state changes at the end of the test
- Limit: state changes on a limit
- Overl 120%: state change when the current reading is more than 20% over the capacity of the sensor. Use to protect the sensor on the test stand.

**The outputs 1 and 2 are connected to the inputs 1 and 2 of the Drivepack**

It is possible to define for each output the state at the beginning of the test: high or low using the following icons:





You can also define how the output changes:



- Output steady state: stay on the same state



- Pulse: Pulse of 50ms..

## 2. Inputs and pedal

The 3 TTL inputs (Pedal, E1 and E2) of the Centor Dual Touch can have the following actions:

- ACTIVE TEST: start a test
- STOP TEST: stop a test
- TARE VX: tare one of the sensor without starting a test
- F. CONTACT: used in the contact calculation

**The input « Pedal » is connected to the green button on the front panel ATLAS II. The default value for this input starts a test.**

It is possible to define for each input the state at the beginning of the test: high or low using the following icons:



## 13. General settings

You can go to the general parameters menu from the main menu « Setup » These parameters are used to manage sounds, sleep, display...

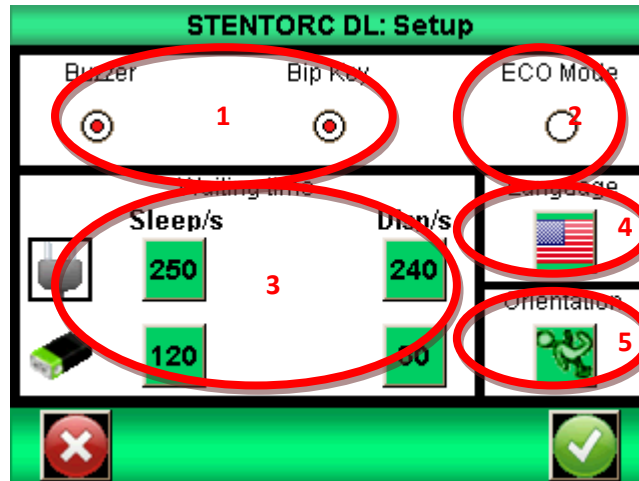

### 1. Buzzer

Buzzer: Activate or deactivate the sound for the alarm.

Beep: Activate or deactivate the sound when you touch the screen

### 2. ECO mode

Reduce the power consumption, useful for long test duration and USB communication.

### 3. Times out settings

You can setup the sleep time of the display when the stand is connected on power supply or batteries:

Sleep / s: Setup the time before the gauge turn off. Press the On/Off button to restart the stand.

Screen / s: Setup the time before the screen turn off. Just press the screen to restart the stand.

### 4. Screen orientation

The display can rotate by 90° increments...

### 5. Language

Select the language you want pressing the flag.

## 14. Maintenance

The maintenance display is available in the main menu using the icon Maintenance.

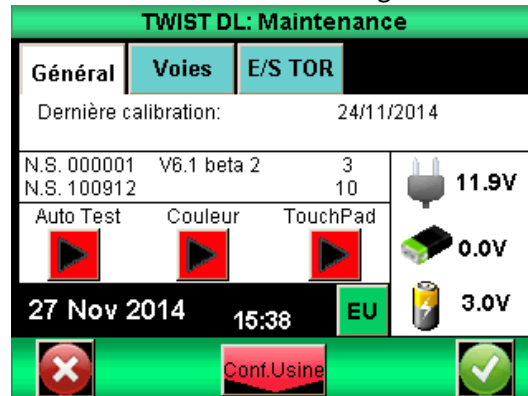

### 1. General

This tab gives the information regarding the sensor, the software version, the battery and date / time.

Auto test: Start a test of the Centor Touch Dual and display the results.

Color: Display the basic colors of the screen

Touch Pad: Calibrate the touch pad

### 2. Date and time

Press the following button:



Change the date and time using the arrows. You can also change the date format:

- UE = day – month – year
- US = month – day - year

### 3. Channels

Display the details of the sensor memory data and the present settings of all input and output signals.

### 4. Factory setting

Reset the gauge with the factory settings

## 15. Examples of test setup

This chapter is designed to give you some examples of setup for your ATLAS II.



### 1. Overload Protection

One of the main problems is to setup the ATLAS II to be sure that it will stop before damaging the force sensor if something wrong happens during a test. Our sensors are protected up to 150% of the full scale. Nevertheless, the ATLAS II can stop on a defined limit or stop when the force reaches 120% of the capacity of the sensor.

Note: Stopping when the force reaches 120% of the capacity of the sensor or to a limit close to the full capacity can also damage the sensor. It is necessary to take into account that the stand has inertia between the time when the command send the information and the time where the stand effectively stops.

### 6. Protection at 120% of the capacity

Got o the menu Maintenance, then tab « TTL I/O». You must setup the output O1 or O2 on « Overl.120% ».

For this output, the state indicator must be on  and type of signal on .

Then using the Drivepack, setup Ext 1 or Ext 2 depending on the output chosen in the Centor Touch Dual on Stop

Ext 1  
Stop

### 7. Stop on a force limit

Go to the menu « Display »  then push « Limits » .

In this example, we have 100N sensor and we want to stop the stand when the force reaches 40N

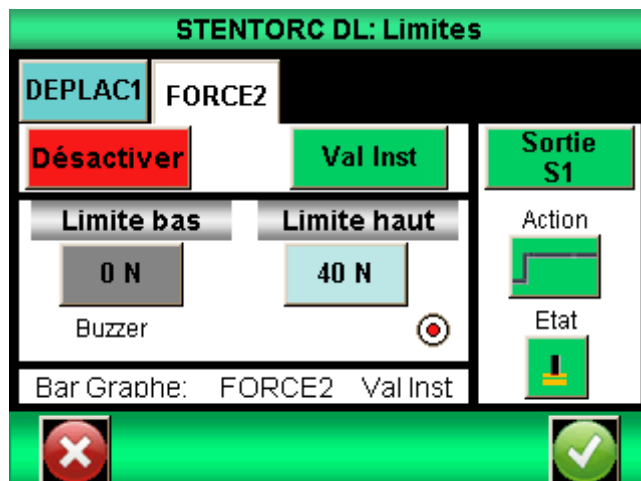

Push the tab « FORCE2 », and then choose in the list menu « Val Inst ».

Setup « Bottom limit » on 0N and « Top limit » on 40N.

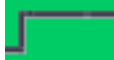
Setup « Output » to activate O1 or O2. For this output, the state indicator must be on  and type of signal on .

Then using the Drivepack, setup Ext 1 or Ext 2 depending on the output chosen in the Centor Touch on Stop

Ext 1  
Stop

## 2. TOPLOAD test – crushing bottle

In order to perform a TOPLOAD test, you must set the tester accordingly. A standard test on bottle (or other type of packaging) requires zeroing the deflection as soon as the top compression platen touches the bottle. The bottle is compressed up to a desired deflection value and the peak force is recorded. Here is a simple example to set a TOPLOAD test requesting to compress the bottle of 10mm and return automatically 5mm above the bottle

### 2.1. Set the Centor Touch

From the main measuring screen, touches the top green bar to access the main menu screen

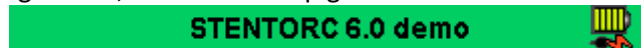

Then select

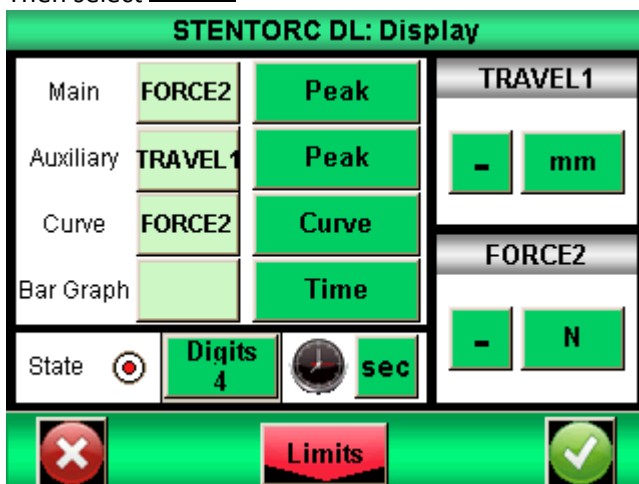

Configure the measuring screen in order to display the peak force on the main display area and the peak deflection value on the auxiliary display area :



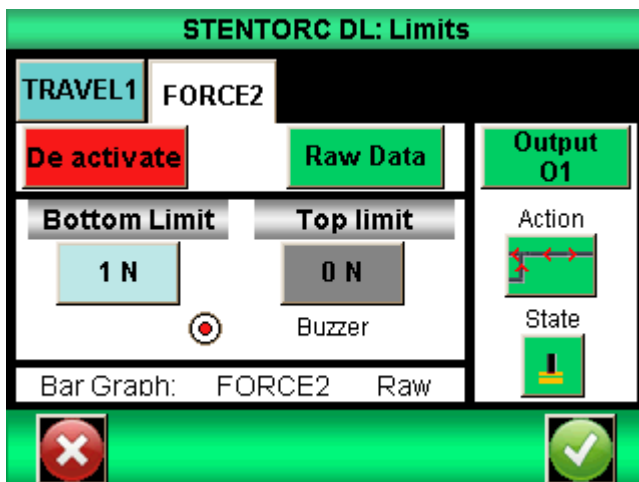

Then select LIMIT



Touches the tab “FORCE2” from the limit screen

Set the down limit to a low value, by example 1% of the full capacity of the load cell (1N for a 100N load cell by example). The ATLAS will zero the deflection once it reaches the force value of 1N (so when it touches the bottle).



Enable the Output 1 and choose the  action on down level . The Centor touch will send a signal to zero the deflection from Drivepack as soon as it reaches the force limit

(1N in our example).

## 2.2. Set the Drivepack command

Set the TOP stop position to STOP (to stop the test at the end)	Pos.stop ↑ Stop
Set the TOP stop position to 5.00mm ( to stop the test at +5.00mm from the 0)	Pos.stop ↑ 5.00 mm
Set the DOWN stop position to inverter (to invert the travel of the tester when it reaches the limit)	Pos.stop ↓ Inverter
Set the DOWN stop position to 10mm (the tester will travel in down position -10mm)	Pos.stop ↓ 10 mm
Set the pedal to Negative start (touching the green start button from the ATLAS, will start the ATLAS test stand in down direction)	Pedal Start Neg
Set the Input 1 to ZERO (to tare the deflection value when receiving a signal on the Input 1)	Input 1 ZERO

## 2.3. Test protocol

- Place the bottle on the work area of the ATLAS. With the manual travel command, move down the top platen until the distance from the bottle is less than 10mm.(this is important as the DOWN limit has been set to 10mm, the tester shouldn't have to travel more than 10mm before reaching the bottle). Press the ZERO button  from the Drivepack command to tare it.
- Push the Green start button  from the ATLAS
- The test protocol starts:
  - Moving down
  - Touching the bottle and at 1N zeroing the deflection values
  - Moving down for 10mm then moving up for 15mm (5mm above the zero position, the top of the bottle)
- The Measuring screen displays the peak force and peak deflection values
- Remove the bottle and place a new one

## 3. Compression spring test

The objective is to set the ATLAS in order to control a compression spring.

How to measure a compression spring?

Measuring a compression spring requires high accuracy and specific setup, by measuring the force at length. In this example the parameters are as followed:

- Free length: 160mm
- Diameter: 30mm
- Ends of the spring are flat
- The last two coils are contiguous
- We want to measure the force at the length of 90mm, with a speed of 25mm/min

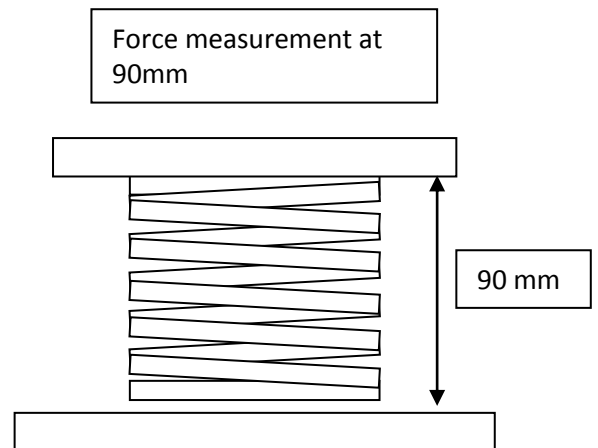
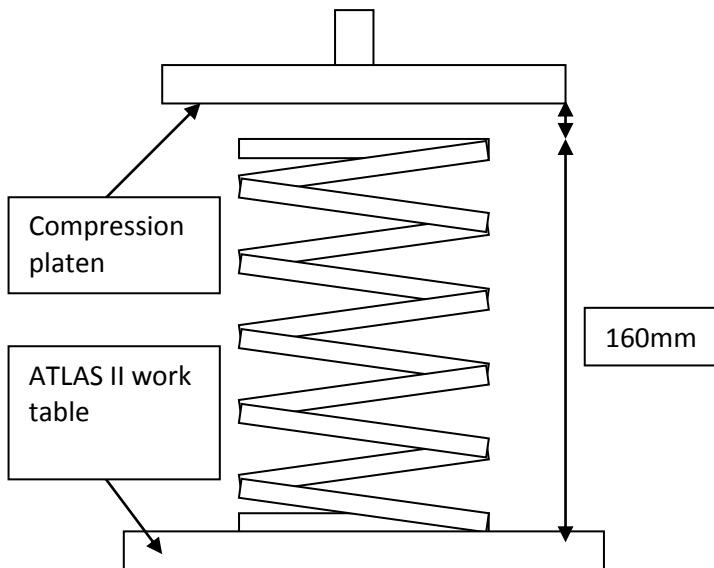

### 3.1. Drivepack configuration

This configuration calls for the following protocol:

The test stand goes down at 25mm/min

The test stand compresses for a height of 90mm

Pause for 1 second then return above 20mm upper the spring (it means 180mm above the work table of the ATLAS) and stop.

Speed  $\uparrow$   
100.00 mm/min

Speed  $\downarrow$   
25.00 mm/min

Stop Pos.  $\uparrow$   
Stop

Stop Pos.  $\uparrow$   
180.00 mm

Stop Pos.  $\downarrow$   
Delayed Inv.

Stop Pos.  $\downarrow$   
90.00 mm

Pause  $\uparrow$   
0

Pause  $\downarrow$   
1

Pedal  
Start Neg.

Input 1  
Inverter

### 3.2. Centor Touch configuration

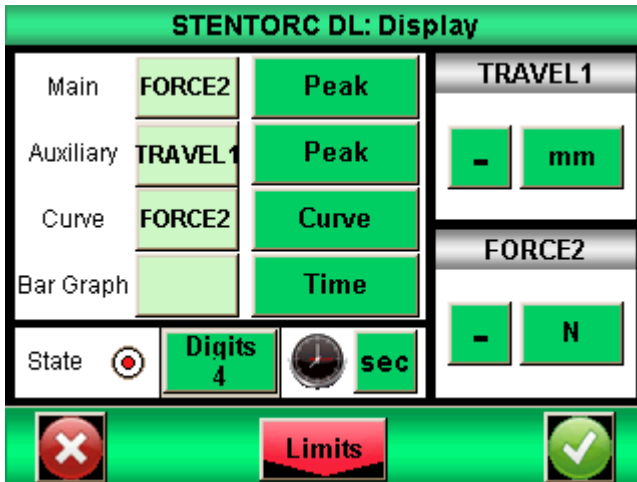



In this example, we are assuming we have a 500N load cell. We are displaying the peak force and maximum deflection values, and with a force limit protection of 400N.

In the “Display” menu sets FORCE2 / Peak as the main display area and TRAVEL1/Peak as the auxiliary area.

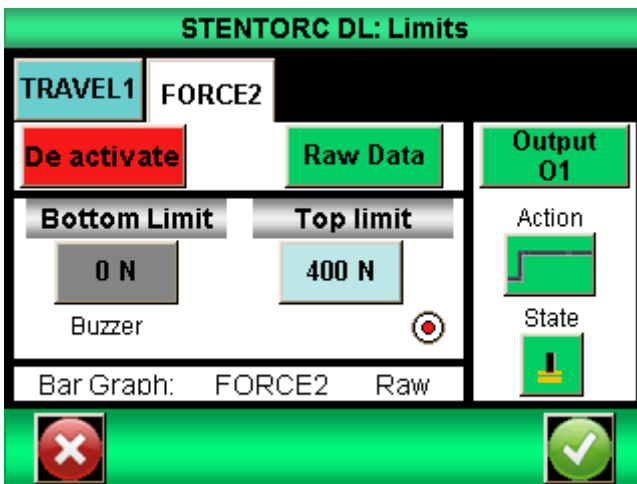
Then press “Limits”,  in order to set the 400N upper limit protection and the Output O1.



Touches the tab “FORCE2” from the limit screen. Set the upper limit to a 400N, enable the Output 1 and choose the  action on down level .

Optional: From the “communication” menu, enable the RS232 or USB connection. Choose “Demand2” and change “Travel1” to “Peak” and “Force1” to “Peak”

### 3.3. Set the original position of the ATLAS

Move the test stand down using the manual command and without any sample on the work table. Using the low speed command, get the upper platen gently in contact with the ATLAS’s work table (Centor Touch should display a force value >0N). Take care as the force can increase very quickly.

Then press the ZERO button from the Drivepack command , to tare the deflection.

Press the key , the test stand is moving up and is stopping 180mm above the work table.

### 3.4. Start the test

Place the compression spring on the work table and below the top compression platen. Press the green START button  until the test stand start to move. The test stand is moving down, compressing the spring at 90mm, stopping for 1 second and then moving up to its starting position.

If the communication has been set, press the key  from the Centor Touch to send the data (peak force and peak deflection).



#### 4. Peeling test

During a peeling test, we want to measure the force required to separate two glued material. Most of the time the required results are peak force (start force) and average force (peeling force).

In this example, we are going to setup the ATLAS II to peel the sample at 80 mm/min during 50mm and display the peak and average value of the force between 5 seconds and 25 seconds.

##### 4.1. Drivepack setup

Speed ↑ 80.00 mm/min
-------------------------

Speed ↓ 200.00 mm/min
--------------------------

Pos stop ↑ Invert
----------------------

Pos stop ↑ 50.00 mm
------------------------

Pos stop ↓ Stop
--------------------

Pos stop ↓ 00.00 mm
------------------------

Pause ↓ 0
--------------

Pause ↓ 1
--------------

Pedal Start Pos.
---------------------

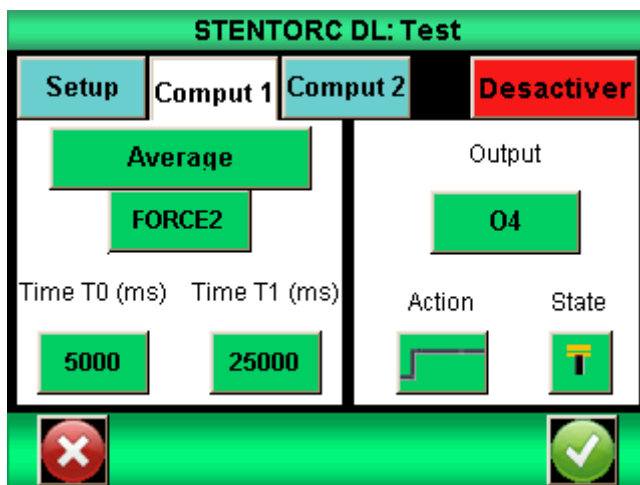

##### 4.2. Centor Touch configuration



In the menu “test”, press tab « Comput 1 », then choose Average and FORCE2. Setup Instant T0 to 5000ms and Instant T1 on 25000ms. Then validate

From the “Display” menu, choose « FORCE2 » and « Peak » for the main display area and « Force2 » and “Average” for auxiliary display area.

### 4.3. Start test

Tare the deflection on the Drivepack using the key . Start the test using the Start button . The ATLAS II will go up and stop after 50mm, then go back to the zero position.

## 5. Wire cable

This test involves measuring the force required to separate a crimp from its cable. The principle is to stop the test once the break force is reached, and returning to its starting position. In this example, the speed is 50mm/min.

### 5.1. Drivepack configuration

Speed ↑ 50.00 mm/min	Speed ↓ 200.00 mm/min
Pos Stop ↓ Stop	Pos stop ↓ 0.00 mm
Pedal Start Pos.	Input 1 Inverter

### 5.2. Centor touch configuration

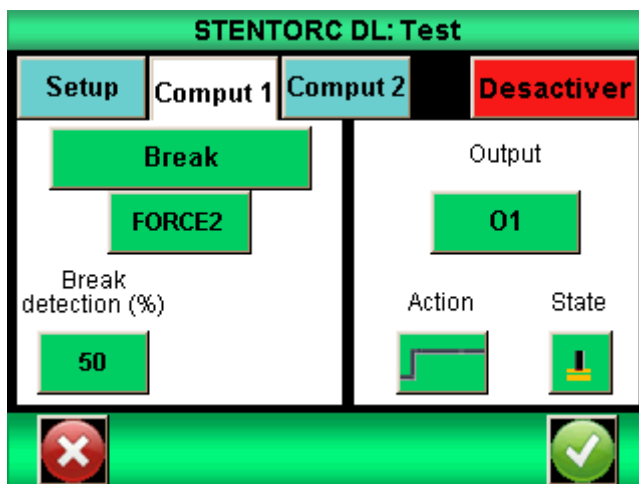

From the “Test” menu, “comput 1” tab, choose “break” from the available calculation and FORCE2. Set the percentage of the breaking force to 50% by example. Choose “Output” O1

Action 

State 

From the “Display” menu, choose “FORCE2” and “break” for the main display area and if you choose to display the deflection select “TRAVEL1” and “peak” for the auxiliary area.

### 5.3. Start the test

Tare the deflection from the ATLAS pressing the ZERO key . Set the wire sample. Press the START green button until the test stand is moving. The Test stand is moving up until the cable break; stops and then return to its starting position.

---

## 16. Annexes

### 1. Software

ANDILOG technologies has developed several programs to save and analyze values.

- You want to control your test stand from your computer, configure sequence tests, analyze your calculation and edit your test reports; CALIFORT Software has been developed to answer to this entire request.
- You only want to capture the graphs on your computer: CALIGRAPH is simple software that will help you to do so.

If you wish to connect your ATLAS II to a PC via one of our programs, contact your ANDILOG technologies dealer.

### 2. Cables

Several interface cables can be used with test stand ATLAS II:

- External pedal: allows simulation of a keyboard button
- Cable for external contact: allows force calculation from closing /opening of contact (equipped with male-female plugs):
- Cable for analog link (with male-female plugs): links your gauge to another system
- Cable for RS232 link: connect your gauge to a computer using the RS232 output
- Cable for USB link: connect your gauge to a computer using the USB output

### 3. Security housing

If your test stand is equipped security housing with a door, opening the door stops the test stand and disables the remote control. To use the setup mode, you have to close the door. When you close the door the stand will not re-start the test from the door open point. You must re-start your test from the beginning.

### 4. Error message

#### 1. On the Centor Touch Dual

This display appears when a minor defect is detected by the instruments when it starts. Minor defects can be:

- Number of overloads is between 1 and 10
- Calibration date passed

Press measure to continue.

**If you don't have the measure button:** At least one error blocks the stand from working properly.

Reasons could be:

- Damaged sensor
- Number of overloads > 10

- Internal error
- Sensor is connected

## 2. On Drivepack

If the ATLAS detects too much current for any reason, the stand is going to stop and you will have the following message:

Dist+      0.00 mm  
SECURITY CURRENT

You have to turn off the test stand and turn on again to reset this protection.

### Internal travel limit

The ATLAS has internal travel limits to stop the test stand before it reaches the end of the power screw. These travel limits cut the power supply of the motor in the direction of the actual travel. You can move the test stand manually in the opposite direction.

Note: After this kind of stop, the value of the displacement could be modified. You have to check this value before doing another test.

### Transmission error

If the remote control cannot communicate with the test stand (for example if the cable is broken), the two systems launch a reset process and switch to a security mode to stop the motor. You have to restart the test stand but your equipment probably needs maintenance.

! SECURITY!  
ERROR CODE # 6

### Security stop

If the system detects that a command is not properly completed, the display shows:

! SECURITY!  
Door / Overl / Pos

In this case you have to check the following:

- If you have security doors, please check that all the doors are closed
- If there is an overload on the motor, remove this overload
- If the stand is in a travel limit position, move the stand in the opposite direction

If you cannot turn on the ATLAS II, the reason may be that one of the 3 protection fuses is broken.

The first fuse is located on the right side of the ATLAS II close to the plug and main power red button. This is a 5A fuse, dimensions 5x20mm.

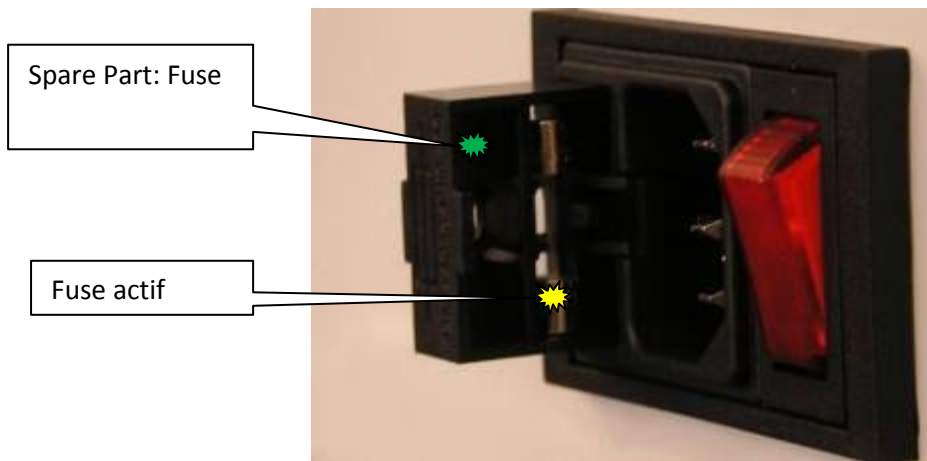

The ATLAS II has two fuses inside the test stand. If you need to change one of these fuses, unplug the ATLAS II. Unscrew the two screws on the front panel and open the front panel of the ATLAS II. The 2 fuses are located on the Drivepack electronic board:

- One fuse of 5A, dimensions 5X20 mm
- One fuse of 200 mA, dimensions 5X20 mm

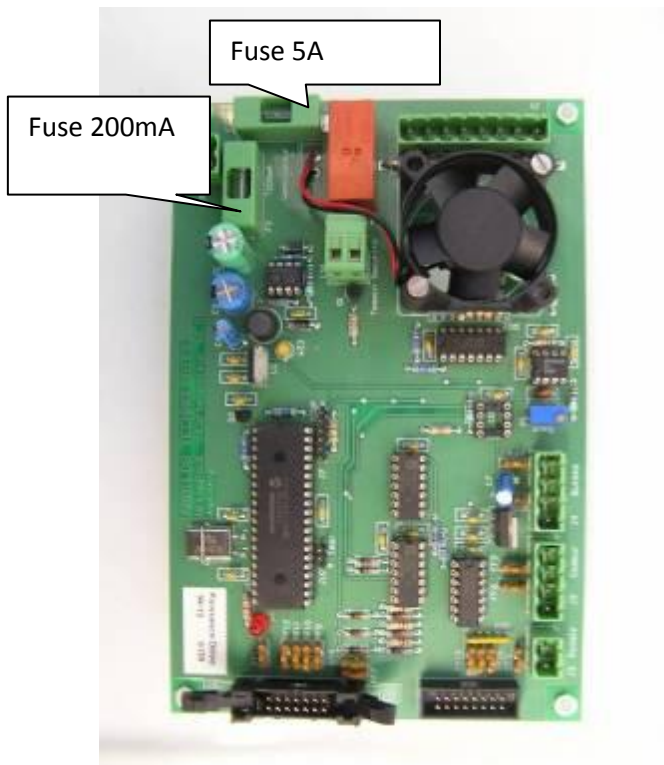

## 5. Factory settings

### Display

**STENTORC DL: Display**

Main	TRAVEL1	Raw Data	TRAVEL1
Auxiliary	FORCE2	Raw Data	+ mm
Curve	TRAVEL1	- Nothing -	FORCE2
Bar Graph	TRAVEL1	Raw Data	+ N
State	<input checked="" type="radio"/>	Digits 4	sec

Limits

### Test

**STENTORC DL: Test**

Activate

### Statistical

**STENTORC DL: Statistics**

Activate

### Communication

**STENTORC DL: Communication**

RS232	ANALOG	USB	DataStick	BlueTooth
De activate	Speed 9600	Parity None		
On demand 1	Stop 1	Bits 8		
TRAVEL1 Peak	Send Key			
FORCE2 Peak				

### Setup

**STENTORC DL: Setup**

Buzzer	Bip Key	ECO Mode
<input checked="" type="radio"/>	<input checked="" type="radio"/>	<input type="radio"/>
Waiting time		Language
Sleep/s	Disp/s	
120	60	Orientation
	120	

### Maintenance

**STENTORC DL: Maintenance**

Setup	Channels	TTL O/I
O1 Nothing	O2 Nothing	O3 Nothing
O4 Nothing	O5 Nothing	O6 Nothing
Pedal - Nothing -	I2 - Nothing -	I1 - Nothing -

## 6. Connections

The ATLAS II has 2 connectors on the right side. The 15 pins connector is connected to the Drivepack and the 26 pins connector is linked to the Centor Touch Dual.

Note that the pedal inputs of the Drivepack and Centor Touch Dual are connected together to the green button on the front panel of the ATLAS II. The output 1 and 2 of the Centor Touch Dual are connected to the input 1 and 2 of the Drivepack.

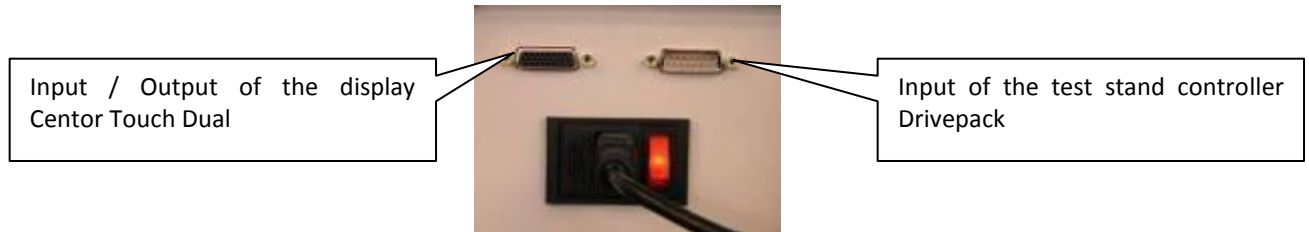

### 1. 26 pins Connector details

SubDHD 26 pins connected to the Centor Touch Dual

1	GND
2	I1 input
3	Not used
4	RS232 read data
5	USB device data minus
6	USB host data minus
7	O3 output. Open collector requires 50 k ohm pull up to 5 volts DC
8	O2 output. Open collector requires 50 k ohm pull up to 5 volts DC
9	Gauge reset
10	Analog output
11	I2 input
12	Not used
13	Not used
14	USB device power
15	USB host power
16	O4 output. Open collector requires 50 k ohm pull up to 5 volts DC.
17	O5 output. Open collector requires 50 k ohm pull up to 5 volts DC.
18	GND
19	Chassis ground
20	Pedal input
21	Not used
22	RS232 transmit data
23	USB device data plus
24	USB host data plus
25	O6 output. Open collector requires 50 k ohm pull up to 5 volts DC.
26	O1 output. Open collector requires 50 k ohm pull up to 5 volts DC.

### 2. 15 points Connector details

Connected to the Drivepack

1	Ground
2	Input for security door
3	Input 1
5	Output
9	Ground
10	Input 2

### 3. Dimensions

